

### STANDARD EQUIPMENT

10 YEAR LIMITED WARRANTY  
 Gooseneck w/ Tapered Nose, Padlock Securable Gates, 37" Wide Escape Door,  
 2 - Double Wall Sliding Center Gate w/ Slam Latch ,  
 Double Wall Sliding Rear Gate w/Posi-Latch, Rubber Rollers on Sliding Gates,  
 Double Wall Smooth Extruded Sidewall, GN Compartment Fold Down Gate,  
 52" High Solid Sides on 6'8" Tall / 60" on 7'4" Tall, Adjustable GN Hitch Height,  
 Full Length Running Boards (7'5" Trailers Only), 2-5/16 Coupler, Rear Skid Plate,  
 Rear Rubber Bumper, Spare Tire Rack, Spare Tire & Wheel for Standard Axle,  
 Single 10K Spring Loaded Drop Leg Jack, Galvanized Subframe and A Frame Under GN  
 T&G Aluminum Floor w/ Aggressive Traction Surface, 4" Aluminum I Beams  
 62" Truck Clearance, Graphics Package, Conspicuity Tape, Wrap Around Latch Rear Gate,  
 Heavy Duty Wiring Harness, Enclosed Brake Wiring, Safety Chains, One Piece Roof,  
 Quick Change Pigtail, 7-Way Plug, High Mount LED Stop, Turn, & Tail Lights,  
 Breakaway Battery w/ Charger & LED Dome Light (Switch on Light) in Front Compartment,  
 LED Lights, Front ID Lights, Rubber Torsion Axles w/ Spindle Lube 8-Bolt Hubs,  
 ST235/85R16 LR G Tires, 3-7K Axles w/ 12" x 2" Electric Brakes on 28'-34'  
 3-8K Axles on 36'-40'



## 6'8" TALL

ITEM	Column1	Column2	AXLE	WEIGHT(LBS)	GVWR	REF#	LIST PRICE
ESTA000100	ES7.5-28-68 GN ENDURA STOCK XD F/G		3-7K		25000	EN523NE05	\$ 42,214
ESTA000102	ES7.5-30-68 GN ENDURA STOCK XD F/G		3-7K		25000	EN533NE76	\$ 43,605
ESTA000104	ES7.5-32-68 GN ENDURA STOCK XD F/G		3-7K		25000	EN643NE47	\$ 44,996
ESTA000106	ES7.5-34-68 GN ENDURA STOCK XD F/G		3-7K		25000	EN753NE18	\$ 46,387
ESTA000108	ES7.5-36-68 GN ENDURA STOCK XD F/G		3-8K		25000	EN214NE33	\$ 53,549
ESTA000110	ES7.5-38-68 GN ENDURA STOCK XD F/G		3-8K		25000	EN324NE04	\$ 54,940
ESTA000112	ES7.5-40-68 GN ENDURA STOCK XD F/G		3-8K		25000	EN334NE75	\$ 56,331

## 7'4" TALL

ITEM	Column1	Column2	AXLE	WEIGHT(LBS)	GVWR	REF#	LIST PRICE
ESTA000120	ES7.5-28-74 GN ENDURA STOCK XD F/G		3-7K		25000	EN643NE05	\$ 44,942
ESTA000122	ES7.5-30-74 GN ENDURA STOCK XD F/G		3-7K		25000	EN653NE76	\$ 46,332
ESTA000124	ES7.5-32-74 GN ENDURA STOCK XD F/G		3-7K		25000	EN763NE47	\$ 47,723
ESTA000126	ES7.5-34-74 GN ENDURA STOCK XD F/G		3-7K		25000	EN873NE18	\$ 49,114
ESTA000128	ES7.5-36-74 GN ENDURA STOCK XD F/G		3-8K		25000	EN334NE33	\$ 56,277
ESTA000130	ES7.5-38-74 GN ENDURA STOCK XD F/G		3-8K		25000	EN444NE04	\$ 57,668
ESTA000132	ES7.5-40-74 GN ENDURA STOCK XD F/G		3-8K		25000	EN454NE75	\$ 59,058

### STANDARD EQUIPMENT

10 YEAR LIMITED WARRANTY  
 Gooseneck w/ Tapered Nose, Padlock Securable Gates, 37" Wide Escape Door,  
 2 - Double Wall Sliding Center Gate w/ Slam Latch,  
 Double Wall Sliding Rear Gate w/Posi-Latch, Rubber Rollers on Sliding Gates,  
 Double Wall Smooth Extruded Sidewall, GN Compartment Fold Down Gate,  
 52" High Solid Sides on 6'8" Tall / 60" on 7'4" Tall, Adjustable GN Hitch Height,  
 2-5/16 Coupler, Rear Skid Plate, Galvanized Subframe and A Frame Under GN  
 T&G Aluminum Floor w/ Aggressive Traction Surface, 4" Aluminum I Beams  
 Rear Rubber Bumper, Spare Tire Rack, Spare Tire & Wheel for Standard Axle,  
 Single 10K Spring Loaded Drop Leg Jack, Flat Floor w/ Traction Surface,  
 62" Truck Clearance, Graphics Package, Conspicuity Tape, Wrap Around Latch Rear Gate,  
 Heavy Duty Wiring Harness, Enclosed Brake Wiring, Safety Chains, One Piece Roof,  
 Quick Change Pigtail, 7-Way Plug, High Mount LED Stop, Turn, & Tail Lights,  
 Breakaway Battery w/ Charger & LED Dome Light (Switch on Light) in Front Compartment,  
 LED Lights, Front ID Lights, Rubber Torsion Axles w/ Spindle Lube 8-Bolt Hubs,  
 ST235/85R16 LR G Tires, 3-7K Axles w/ 12" x 2" Electric Brakes on 28'-34'  
 3-8K Axles on 36'-40'



## 6'8" TALL

ITEM	Column1	Column2	AXLE	WEIGHT(LBS)	GVWR	REF#	LIST PRICE
ESTA000140	ES8-28-68 GN	ENDURA STOCK XD F/G	3-7K		25000	EN733NE86	\$ 43,878
ESTA000142	ES8-30-68 GN	ENDURA STOCK XD F/G	3-7K		25000	EN843NE57	\$ 45,269
ESTA000144	ES8-32-68 GN	ENDURA STOCK XD F/G	3-7K		25000	EN953NE28	\$ 46,660
ESTA000146	ES8-34-68 GN	ENDURA STOCK XD F/G	3-7K		25000	EN963NE99	\$ 48,051
ESTA000148	ES8-36-68 GN	ENDURA STOCK XD F/G	3-8K		25000	EN524NE14	\$ 55,213
ESTA000150	ES8-38-68 GN	ENDURA STOCK XD F/G	3-8K		25000	EN534NE85	\$ 56,604
ESTA000152	ES8-40-68 GN	ENDURA STOCK XD F/G	3-8K		25000	EN644NE56	\$ 57,995

## 7'4" TALL

ITEM	Column1	Column2	AXLE	WEIGHT(LBS)	GVWR	REF#	LIST PRICE
ESTA000160	ES8-28-74 GN	ENDURA STOCK XD F/G	3-7K		25000	EN853NE86	\$ 46,605
ESTA000162	ES8-30-74 GN	ENDURA STOCK XD F/G	3-7K		25000	EN963NE57	\$ 47,996
ESTA000164	ES8-32-74 GN	ENDURA STOCK XD F/G	3-7K		25000	EN083NE28	\$ 49,387
ESTA000166	ES8-34-74 GN	ENDURA STOCK XD F/G	3-7K		25000	EN093NE99	\$ 50,778
ESTA000168	ES8-36-74 GN	ENDURA STOCK XD F/G	3-8K		25000	EN644NE14	\$ 57,940
ESTA000170	ES8-38-74 GN	ENDURA STOCK XD F/G	3-8K		25000	EN654NE85	\$ 59,331
ESTA000172	ES8-40-74 GN	ENDURA STOCK XD F/G	3-8K		25000	EN764NE56	\$ 60,722

## ENDURA STOCK AXLE/BRAKE/TIRE OPTIONS

### OPTIONS FOR (3) 7K RUBBER TORSION AXLES W/ST235/85R16 LRG TIRES

ITEM			REF#	LIST PRICE
X9138	8K AXLE (3), RUBBER TORSION ILOS (3)7K	ST235/85R16 LRG, 25000 GVWR	AL520SO01	\$ 3,248
X9139	10K AXLE (3), RUBBER TORSION ILOS (3)7K	235/75R17.5 LRJ, 35900 GVWR	AL950SO38	\$ 7,712
X9068	8K AXLES (2), RUBBER TORSION ILOS (3)7K	ST235/85R16 LRG, 17500 GVWR	AL300SO96	\$ 514
X9132	8K AXLES (2) ILOS (3)7K AXLES	235/75R17.5 LRJ, 17500 GVWR	AL020SO80	\$ 2,701
X9069	10K AXLES (2), RUBBER TORSION ILOS (3)7K	235/75R17.5 LRJ, 35900 GVWR	AL730SO12	\$ 4,821

### OPTIONS FOR (3) 8K RUBBER TORSION AXLES W/ST235/85R16 LRG TIRES

ITEM			REF#	LIST PRICE
X9141	10K AXLES (3), RUBBER TORSION ILOS (3)8K	235/75R17.5 LRJ, 35900 GVWR	AL430SO37	\$ 4,464
<i>*Trailers with triple 10K axles have a higher than 26,000# hauling capacity and will need to be charged FET( Federal Excise Tax)</i>				

### BRAKES

ITEM			REF#	LIST PRICE
X9070	ELECTRIC/HYDRAULIC BRAKES, ILOS 2 ELECT		BR720BR02	\$ 3,509
X9071	ELECTRIC/HYDRAULIC BRAKES, ILOS 3 ELECT		BR030BR61	\$ 3,975

### TIRE/WHEEL OPTIONS (ILOS)

ITEM			REF#	LIST PRICE
X9072	T/W ST235/85R 16 LR G ILOS 16E	Westlake	AL100SO59	\$ 206
X9074	T/W 235/75R 17.5 LR J ILOS 16E	Westlake	AL200SO68	\$ 348
X9142	T/W 235/75R 17.5 LR J ILOS 16G	Westlake	AL100SO08	\$ 140

### TIRE/WHEEL OPTIONS (ADDITIONAL SPARE)

ITEM			REF#	LIST PRICE
234294	TIRE & WHEEL ST235/80R16E W/SL MOD LION	Castle Rock	TI100WH92	\$ 249
234296	TIRE & WHEEL ST235/85R16G W/SL MOD LION	Westlake	TI300WH22	\$ 418
234398	TIRE & WHEEL 235/75R17.5J W/SL MOD LION	Westlake	TI400WH54	\$ 590
X9076	ALUMINUM SPOKE T/W ILOS 16" WHEEL	*price per wheel	AL100SO97	\$ 256
X9075	ALUM WHEEL ILOS 17.5 J WHEEL	*price per wheel	AL100SO97	\$ 256

# ENDURA STOCK ACCESSORIES AND OPTIONS

## BODY & FRAME OPTIONS

ITEM			REF#	LIST PRICE
X9003	3" SLOTTED SIDES (28" FROM FLOOR)	<i>per Trailer</i>	AL200SO09	\$ 271
X9001	FRONT VENT & COVER		AL300SO26	\$ 423
X9004	TIE RAIL (INSIDE OR OUTSIDE)	<i>per ft.</i>	AL000SO24	\$ 31
231744	TIE LOOP CAST AL	<i>Bolt-On, External (price each)</i>	MI000 P08	\$ 10
89321	TIE LOOP, 1/2" AL ROUND X 7-1/2"	<i>Weld-On, Internal (price each)</i>	AL000 P07	\$ 9
X9007	DUAL JACK, SINGLE SPEED ILOS	<i>Gooseneck Only</i>	AL300SO08	\$ 400
X9008	DUAL JACK, 2 SPD GEARBOX ILOS	<i>Gooseneck Only</i>	AL600SO37	\$ 827
X9009	12K ELECT/HYD BIG FOOT JACK ILOS	<i>Gooseneck Only, Includes Battery</i>	AL520SO07	\$ 3,256

## ESCAPE DOOR & SIDE RAMP OPTIONS (14,500 GVWR)-Restrictions may apply to placement

ITEM			REF#	LIST PRICE
X9016	ADDITIONAL 37" ESCAPE DOOR, EITHER SIDE		AL700SO25	\$ 942
X9127	52" WIDE ESCAPE DOOR, ADDITIONAL		AL900SO65	\$ 1,253
X9013	52" WIDE ESCAPE DOOR ILOS		AL200SO47	\$ 321
X9128	52" WIDE ESCAPE DOOR, NO SILL, ILOS 37"		AL010SO58	\$ 1,374
X9129	52" WIDE ESCAPE DOOR, NO SILL, ADD		AL710SO78	\$ 2,309
X9015	52" WIDE FOLD DOWN SIDE RAMP		AL020SO93	\$ 2,718
X9014	52" WIDE FOLD DOWN SIDE RAMP ILOS		AL310SO76	\$ 1,787
X9130	52"W FOLD DOWN SIDE RAMP, NO SILL, ADD		AL920SO04	\$ 3,771
X9131	52"W FOLD DOWN SIDE RAMP, NO SILL, ILOS		AL120SO88	\$ 2,842
X9017	FULLY ENCLSD LIVESTOCK ESCAPE DOOR ILOS		AL100SO44	\$ 187

## CENTER GATE OPTIONS

ITEM			REF#	LIST PRICE
X9020	DELETE SLIDING CENTER GATE & POSTS		AL00-SO40	\$ (540)
X9021	MOVE CENTER GATE FROM STANDARD POSITION		AL100SO96	\$ 255
X9022	ADJ SOLID CNTR GATE ILOS, NO SLIDER		AL210SO54	\$ 1,629
X9023	ADJ SOLID CNTR GATE, NO SLIDER		AL520SO04	\$ 3,252
X9134	ADJ SLIDING CNTR GATE ILOS		AL410SO75	\$ 1,916
x9133	ADJ SLIDING CNTR GATE		AL720SO24	\$ 3,538
X9002	ADD SLIDING CENTER GATE		AL210SO51	\$ 1,625
X9024	SOLID CENTER GATE ILOS		AL000SO00	\$ -
X9025	ADDITIONAL SOLID CENTER GATE		AL010SO64	\$ 1,382
X9026	ADDITIONAL SET OF CENTER GATE POSTS		AL400SO26	\$ 553
X9027	3" SLOT IN CENTER GATE		AL000SO81	\$ 105
X9140	PEN (1 PAIR, 4' LONG)		AL310SO15	\$ 1,708

## REAR GATE OPTIONS (ILOS)

ITEM			REF#	LIST PRICE
X9028	SOLID REAR GATE (NON-SLIDING)	<i>w/ Standard L.S. Opening</i>	AL000SO00	\$ -
X9029	ENCLOSED SOLID (NON-SLIDING) REAR GATE		AL000SO00	\$ -
X9030	1/2 ROLL-UP DOOR IN LIVESTOCK REAR GATE		AL600SO77	\$ 879
X9031	3" SLOT IN REAR GATE		AL000SO81	\$ 105
X9032	DOUBLE REAR DOORS WITH CAM LATCH		AL200SO42	\$ 314
X9033	DBL REAR DOORS W/ FOLD AROUND HINGES	<i>Lay Flat Hinges</i>	AL600SO26	\$ 813
X9137	4' REAR RAMP BEHIND REAR GATE		AL420SO40	\$ 3,169

<b>GN COMPARTMENT GATES &amp; DOORS</b>				
<b>ITEM</b>	<b>DESCRIPTION</b>	<b>NOTES</b>	<b>REF#</b>	<b>LIST PRICE</b>
X9010	GN SLAM DOOR W/ LOCK	Available on Both Sides	AL400SO03	\$ 523
X9011	WINDOW IN GOOSENECK COMPARTMENT 15X34	Available on Both Sides	AL200SO38	\$ 309
X9012	GN SLAM DOOR WITH LOCK ON FRONT OF NOSE	Drop Down	AL600SO26	\$ 813
X9018	EZ STORE RAMPS ILOS FOLD DOWN GN GATE		AL300SO06	\$ 397

<b>DOUBLE DECK OPTIONS</b>				
<b>ITEM</b>	<b>DESCRIPTION</b>	<b>NOTES</b>	<b>REF#</b>	<b>LIST PRICE</b>
X9036	DOUBLE DECK RAIL, PER FT. OF TRAILER		AL000SO34	\$ 44
X9037	SPLIT SLIDING CENTER GATE ILOS		AL500SO42	\$ 704
X9038	SPLIT SLIDING REAR GATE ILOS		AL500SO42	\$ 704
X9039	SPLIT ESCAPE DOOR		AL100SO56	\$ 203
X9040	DOUBLE DECK FLOORING, 7' WIDTH, PER FT	weight rating 70lbs per sqft per ft	AL100SO17	\$ 152
X9041	DOUBLE DECK FLOORING, 8' WIDTH, PER FT	weight rating 70lbs per sqft per ft	AL100SO31	\$ 170

**\*\* weight rating 70lbs per sqft per ft**

<b>LIGHTING OPTIONS</b>				
<b>ITEM</b>	<b>DESCRIPTION</b>	<b>NOTES</b>	<b>REF#</b>	<b>LIST PRICE</b>
X9042	LED LOADING LIGHT - REQUIRES SWITCH	1900 Lumens	AL100SO49	\$ 194
X9043	RECESSED TOGGLE SWITCH - DOME OR LOAD		AL000SO50	\$ 65
X9045	EXTRA LED CLEARANCE LIGHTS (PER PAIR)		AL000SO58	\$ 75
X9046	RECESSED 3 WAY TOGGLE SWITCH	Requires 2	AL000SO62	\$ 81
X9047	LED BACK UP LIGHTS (PER PAIR)		AL300SO08	\$ 400
X9048	LED DOME LIGHT		AL000SO62	\$ 81

<b>VENTS</b>				
<b>ITEM</b>	<b>DESCRIPTION</b>	<b>NOTES</b>	<b>REF#</b>	<b>LIST PRICE</b>
X9049	CRANK-UP ROOF VENT		AL100SO54	\$ 200
X9050	DRAFT/EXHAUST (POP-UP) ROOF VENT		AL100SO42	\$ 184

<b>RUBBER MAT (Add rubber matting cost and installation cost)</b>				
<b>ITEM</b>	<b>DESCRIPTION</b>	<b>NOTES</b>	<b>REF#</b>	<b>LIST PRICE</b>
X9051	1/2"X60"X84" RUBBER MATTING	per Sheet	AL100SO51	\$ 196
X9052	3/4"X60"X84" RUBBER MATTING	per Sheet	AL100SO80	\$ 234
X9053	INSTALLATION OF MATTING FOR 7.0' TRAILER		AL100SO88	\$ 244
X9054	INSTALLATION OF MATTING FOR 7.5' AND 8.0		AL200SO99	\$ 388

<b>PLEXI-GLASS &amp; STORAGE</b>				
<b>ITEM</b>	<b>DESCRIPTION</b>	<b>NOTES</b>	<b>REF#</b>	<b>LIST PRICE</b>
91899	ENDURA PLEXIGLASS HARDWARE KIT		KI100KI23	\$ 160
233851	PLEXIGLASS STRIP 3/16 X 7-3/16 X 96 BRNZ	Sold in 8' Lengths	MI000 P55	\$ 71
X9035	PLEXI-GLASS INSTALLED AT HILLSBORO	per ft.	AL000SO65	\$ 84
X9034	PLEXI-GLASS STORAGE TRAY	GN or Straight Hitch Trailer	AL300SO94	\$ 512

**\*\* Plexi-Glass Install Kit Includes: 50 retention plugs, 14 filler end pieces, 1 drill guide, and installation instructions**

**\*\*\* Plexi-Glass Installed per foot of trailer, Includes 2 slots left side, 2 slots right side, escape door & rear gate**

**\*\*\*\*Pricing = MSRP \* Length(feet) of Trailer, Includes 2 slots left side, 2 slots right side, escape door & rear gate**

<b>COMBO ROOF COVE &amp; GOOSENECK NOSE BLACK</b>				
<b>ITEM</b>	<b>DESCRIPTION</b>	<b>NOTES</b>	<b>REF#</b>	<b>LIST PRICE</b>
X9056	(1) PAINT ROOF COVE - BLACK	(Trailer + Nose Length) * MSRP = Price	AL000SO35	\$ 45
X9057	(2) PAINT GOOSENECK NOSE BLACK	Includes Nose and Sides	AL400SO90	\$ 636

**\*\* example (1)+(2) :7x20+8' nose = (28 ft total trailer x \$45= \$1260)+(\$636) = \$1896**

<b>PAINT ROOF COVE /ft of total trailer length (include gooseneck &amp; 2' V-Nose)</b>				
<b>ITEM</b>	<b>DESCRIPTION</b>	<b>NOTES</b>	<b>REF#</b>	<b>LIST PRICE</b>
X9055	PAINT ROOF COVE - BLACK	(Trailer + Nose Length) * MSRP = Price	AL000SO35	\$ 45

**\*\* Example: SH 7x18 + 2' v-Nose = 20 ft total trailer X \$45 = \$900**

# ENDURA LIVESTOCK AND COMBO OPTIONS

## BODY & FRAME OPTIONS

ITEM				REF#	LIST PRICE
X9077	FULLY ENCLOSE SIDE (PER FT)		per ft./ per side	AL000SO63	\$ 82

## DRESSING ROOM OPTIONS (d/r)

ITEM				REF#	LIST PRICE
X9078	ANGLED D/R W/ SEALED DOOR, 2; SHORT WALL		Deletes Escape Door	AL610SO12	\$ 2,094
X9079	4' RECTANGULAR D/R W/ SEALED D/R DOOR		Deletes Escape Door	AL610SO12	\$ 2,094
X9080	SLIDE OUT CAMPER STEP - D/R DOOR		N/A on 8' W Trailer	AL200SO53	\$ 329
X9081	SADDLE RACK, 2 PEDESTAL			AL500SO00	\$ 649
X9082	SADDLE RACK, 3 PEDESTAL			AL600SO16	\$ 800
X9083	SADDLE RACK, 4 PEDESTAL			AL700SO36	\$ 956
X9084	TACK HOOKS, BAR OF 6			AL000SO71	\$ 92
X9085	BRUSH TRAY - SPECIFY PLACEMENT			AL000SO75	\$ 97
X9086	BLANKET BAR			AL000SO62	\$ 81
X9088	WALK THROUGH DOOR FROM D/R TO LIVESTOCK			AL600SO54	\$ 849

## LIVESTOCK/HORSE COMPARTMENT OPTIONS

ITEM				REF#	LIST PRICE
X9089	SLANT STALL DIVIDER, PADDED			AL700SO72	\$ 1,003
X9090	SLANT STALL DIVIDER, PADDED, TELESCOPING			AL010SO71	\$ 1,391
X9091	FULL SLANT STALL DIVIDER/STUD GATE ILOS			AL010SO51	\$ 1,365
X9092	PADDING ON LIVESTOCK SIDE OF ANGLE WALL			AL000SO98	\$ 127
X9093	KICK PANEL - RUBBER 48" HEIGHT		Head Side, per ft.	AL000SO69	\$ 90
94263	BOLT-ON TIE LOOP PACKAGE		External (price each)	EN000NE37	\$ 48
89321	TIE LOOP, 1/2" AL ROUND X 7-1/2"		Weld-On, Internal (price each)	AL000 P07	\$ 9
X9004	TIE RAIL (INSIDE OR OUTSIDE)		per ft.	AL000SO24	\$ 31

## WINDOWS

ITEM				REF#	LIST PRICE
X9011	WINDOW IN GOOSENECK COMPARTMENT 15X34		Available on Both Sides	AL200SO38	\$ 309
X9095	SIDE WINDOW 14X21			AL200SO05	\$ 266

# ENDURA PAINT & POLISH OPTIONS

GREEN = PAINT

OPTION 1: PAINT ROOF COVE BLACK  
INCLUDES SIDES AND FRONT

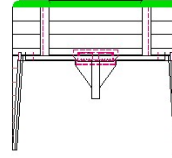
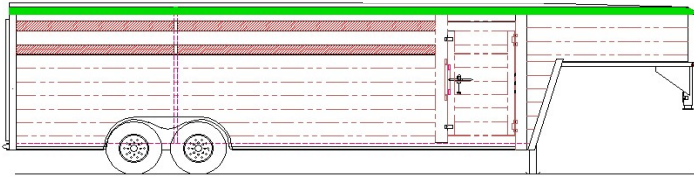

OPTION 2: PAINT NOSE BLACK  
INCLUDES SIDES AND FRONT

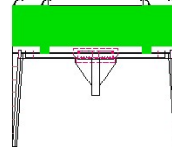
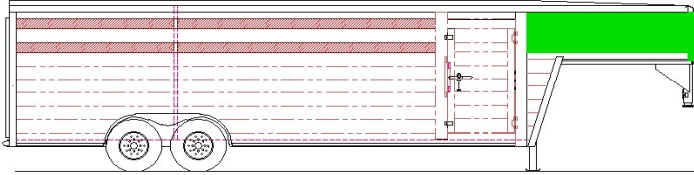

OPTION 3: PAINT ROOF COVE AND NOSE BLACK  
COMBINE COST OF OPTION 1 AND OPTION 2 FOR DEALER COST

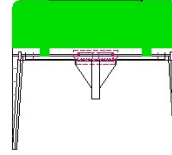
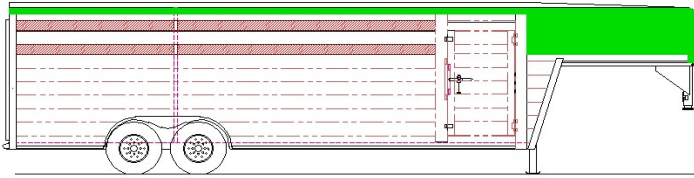

TITLE						<p><i>Hillsboro Industries</i> 220 Industrial Road Hillsboro, KS 67063</p> <p>1-800-835-0209 hi@hillsboroindustries.com www.hillsboroindustries.com</p>	
PAINT OPTIONS							
DWG NO.	REV	DATE	DRAWN BY	SCALE	PAGE		
	A	12-7-16	APD	1/60			

# ENDURA STOCK TRAILERS 7'6"W CENTER GATE PASS-THROUGH WIDTH

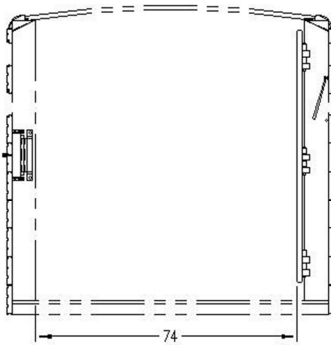

PASS-THROUGH WIDTH  
W/ 6K, 7K OR 7.2K AXLES  
SHOWN WITH CENTER GATE OPEN

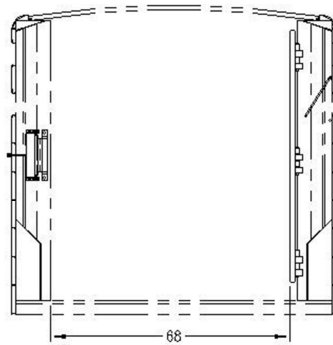

PASS-THROUGH WIDTH  
W/ 8K AXLES  
SHOWN WITH CENTER GATE OPEN

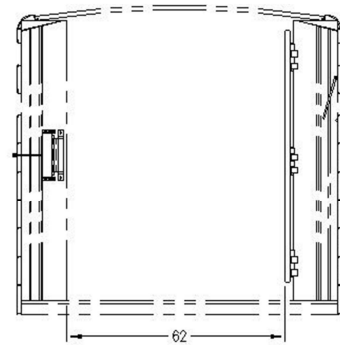

PASS-THROUGH WIDTH  
W/ 10K AXLES  
SHOWN WITH CENTER GATE OPEN

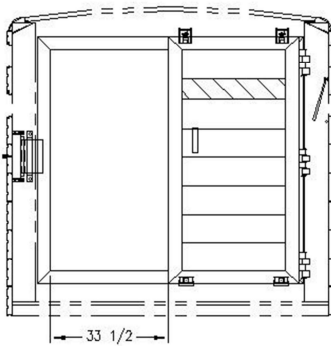

PASS-THROUGH WIDTH  
W/ 6K, 7K OR 7.2K AXLES  
SHOWN WITH ROLLER DOOR OPEN

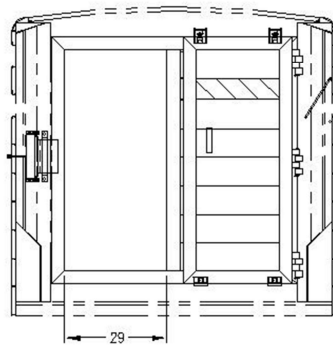

PASS-THROUGH WIDTH  
W/ 8K AXLES  
SHOWN WITH ROLLER DOOR OPEN

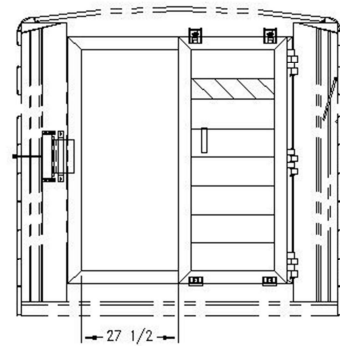

PASS-THROUGH WIDTH  
W/ 10K AXLES  
SHOWN WITH ROLLER DOOR OPEN

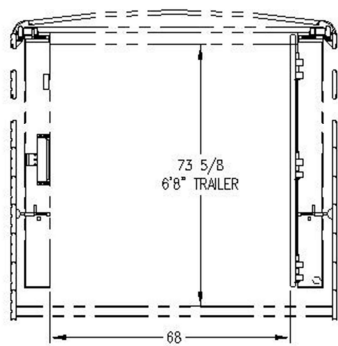

PASS-THROUGH DIMENSIONS  
ADJUSTABLE POSITION CENTER GATE

# ENDURA STOCK TRAILERS 8'2"W

## CENTER GATE PASS-THROUGH WIDTH

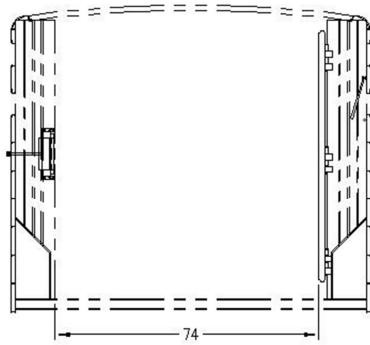

PASS-THROUGH WIDTH  
W/ 6K, 7K OR 7.2K AXLES  
SHOWN WITH CENTER GATE OPEN

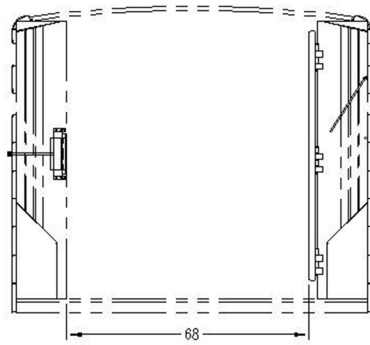

PASS-THROUGH WIDTH  
W/ 8K AXLES  
SHOWN WITH CENTER GATE OPEN

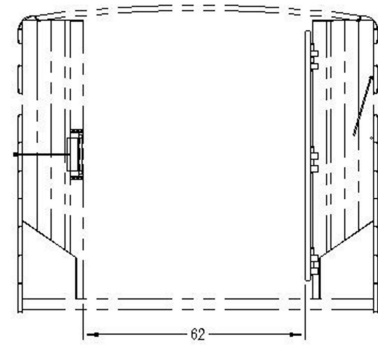

PASS-THROUGH WIDTH  
W/ 10K AXLES  
SHOWN WITH CENTER GATE OPEN

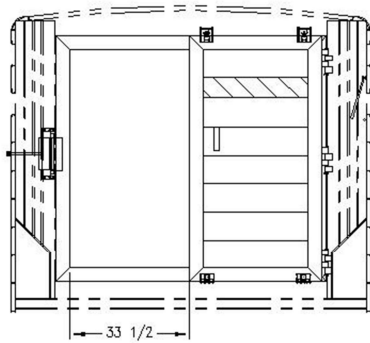

PASS-THROUGH WIDTH  
W/ 6K, 7K OR 7.2K AXLES  
SHOWN WITH CENTER GATE OPEN

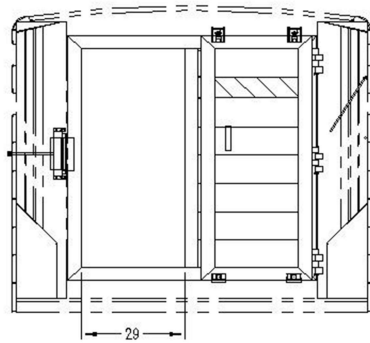

PASS-THROUGH WIDTH  
W/ 8K AXLES  
SHOWN WITH CENTER GATE OPEN

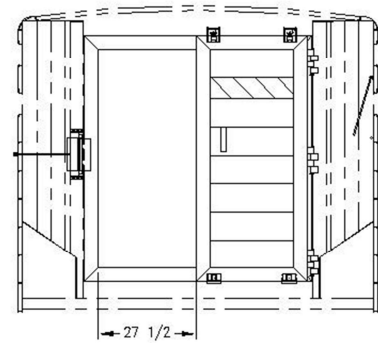

PASS-THROUGH WIDTH  
W/ 10K AXLES  
SHOWN WITH CENTER GATE OPEN

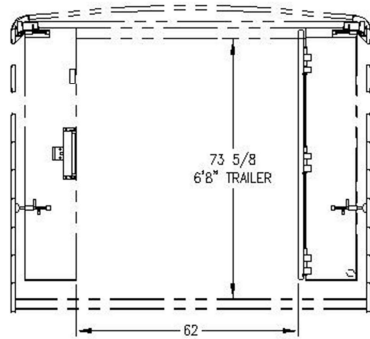

PASS-THROUGH DIMENSIONS  
ADJUSTABLE POSITION CENTER GATE

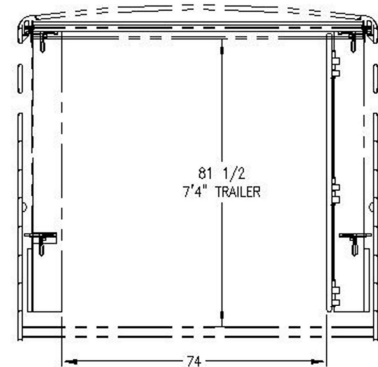

# REAR GATE CONFIGURATIONS, ENDURA STOCK TRAILERS 7'6"W 6'8"T

## STANDARD CONFIGURATION

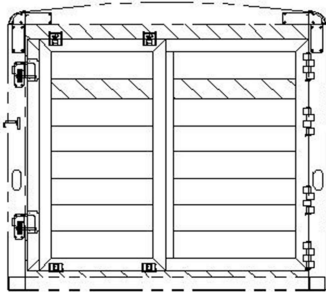

6'8" TALL, STANDARD LIVESTOCK SLIDER  
REAR OPENING - 82W X 76T

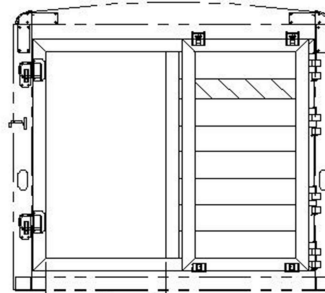

35  
PASS-THROUGH WIDTH  
STANDARD SLIDING REAR GATE  
SHOWN WITH ROLLER GATE OPEN

## OPTIONAL CONFIGURATIONS

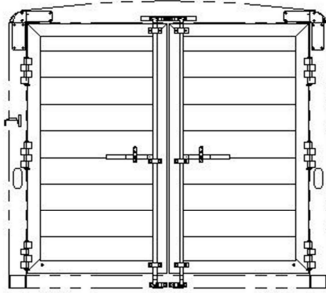

6'8" TALL, DOUBLE DOORS  
REAR OPENING - 88 7/8" X 75T  
CAM LATCH WITH STANDARD HINGES

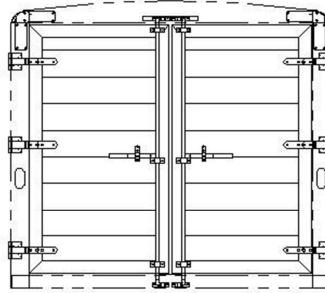

6'8" TALL, DOUBLE DOOR  
REAR OPENING - 88 7/8" X 75T  
CAM LATCH WITH LAY-FLAT HINGES

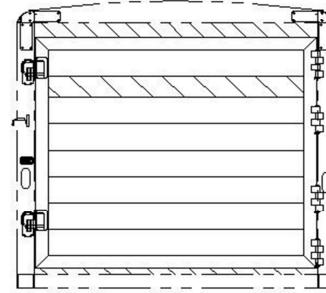

6'8" TALL, SOLID GATE  
REAR OPENING - 82W X 76T

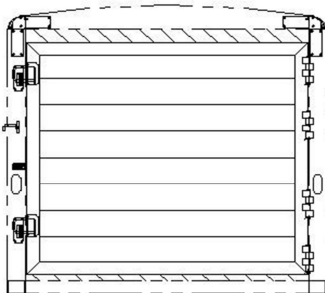

6'8" TALL, ENCLOSED SOLID GATE  
REAR OPENING - 82W X 76T

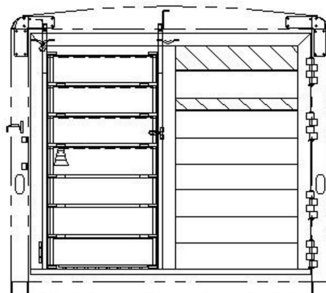

6'8" TALL, HALF ROLL-UP, 32 1/4" OPENING WIDTH  
REAR OPENING - 82W X 76T

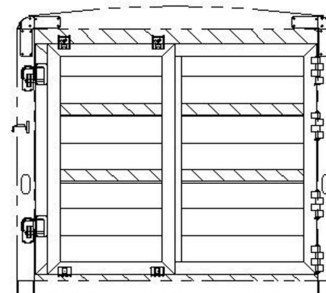

6'8" TALL, SLOTTED ROLLER GATE  
REAR OPENING - 82W X 76T

# REAR GATE CONFIGURATIONS, ENDURA STOCK TRAILERS 7'6"W 7'4"T

## STANDARD CONFIGURATION

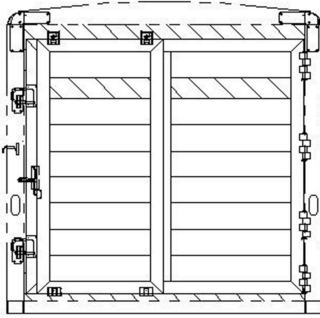

7'4" TALL, STANDARD LIVESTOCK SLIDER  
REAR OPENING - 82W X 84T

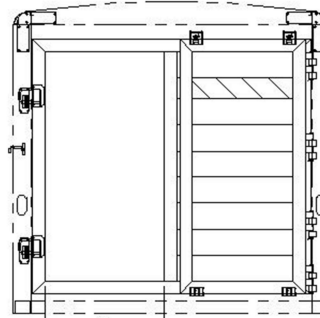

35  
PASS-THROUGH WIDTH  
STANDARD SLIDING REAR GATE  
SHOWN WITH ROLLER GATE OPEN

## OPTIONAL CONFIGURATIONS

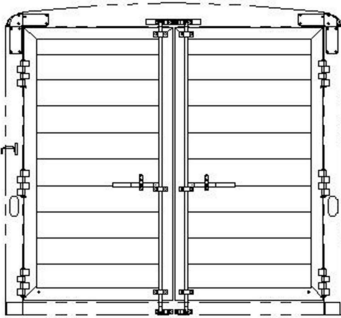

7'4" TALL, DOUBLE DOOR  
REAR OPENING - 88 7/8W X 83T  
CAM LATCH WITH STANDARD HINGES

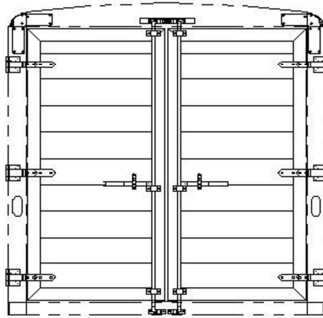

7'4" TALL, DOUBLE DOOR  
REAR OPENING - 88 7/8W X 83T  
CAM LATCH WITH LAY-FLAT HINGES

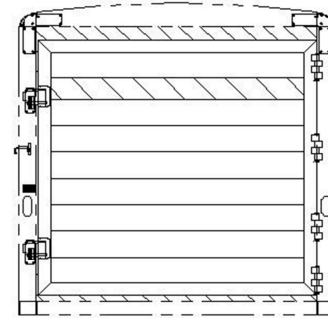

7'4" TALL, SOLID GATE  
REAR OPENING - 82W X 84T

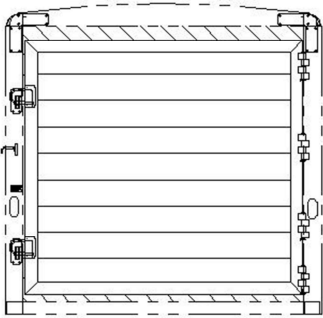

7'4" TALL, ENCLOSED SOLID GATE  
REAR OPENING - 82W X 84T

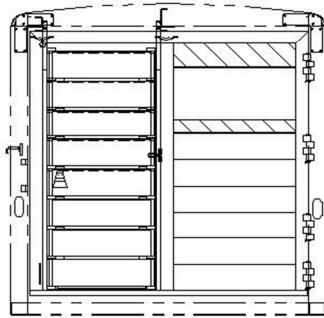

7'4" TALL, HALF ROLL-UP, 32 1/4" OPENING WIDTH  
REAR OPENING - 82W X 84T

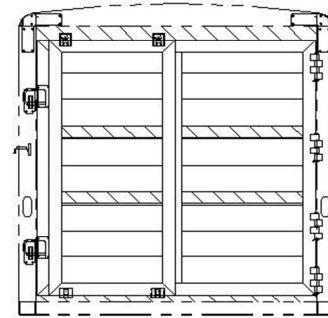

7'4" TALL, SLOTTED ROLLER GATE  
REAR OPENING - 82W X 84T

# REAR GATE CONFIGURATIONS, ENDURA STOCK TRAILERS 8'2"W 6'8"T

## STANDARD CONFIGURATION



6'8" TALL, STANDARD LIVESTOCK SLIDER  
REAR OPENING - 90 1/2" X 76"

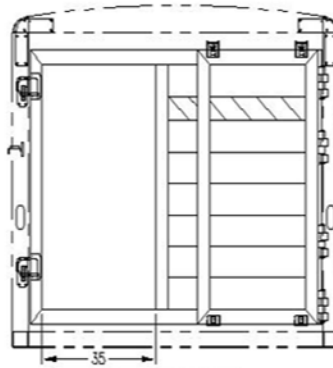

PASS-THROUGH WIDTH  
STANDARD SLIDING REAR GATE  
SHOWN WITH ROLLER GATE OPEN

## OPTIONAL CONFIGURATIONS

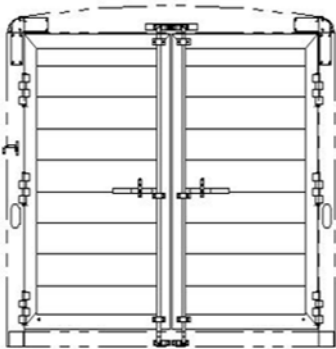

6'8" TALL DOUBLE DOORS  
REAR OPENING - 88 7/8" X 75"  
CAM LATCH WITH STANDARD HINGES

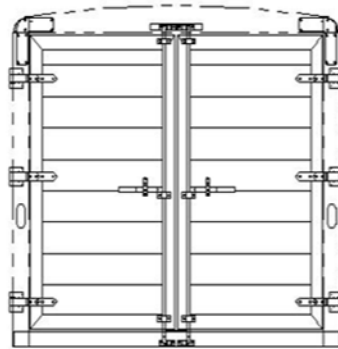

6'8" TALL DOUBLE DOOR  
REAR OPENING - 88 7/8" X 75"  
CAM LATCH WITH LAY-FLAT HINGES

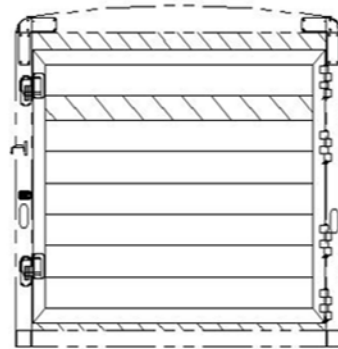

6'8" TALL SOLID GATE  
REAR OPENING - 90 1/2" X 76"



6'8" TALL, ENCLOSED SOLID GATE  
REAR OPENING - 90 1/2" X 76"

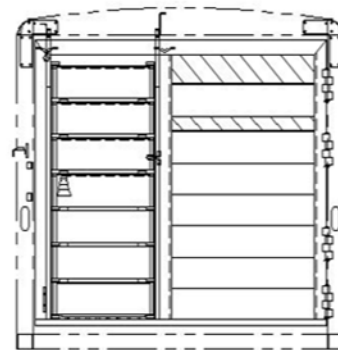

6'8" TALL, HALF ROLL-UP, 32 1/4" OPENING WIDTH  
REAR OPENING - 90 1/2" X 76"

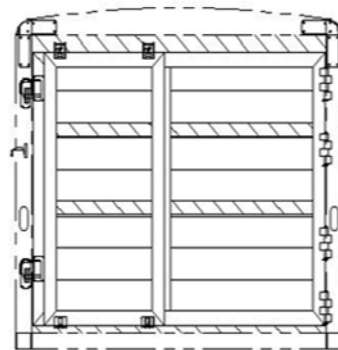

6'8" TALL, SLOTTED ROLLER GATE  
REAR OPENING - 90 1/2" X 76"

# REAR GATE CONFIGURATIONS, ENDURA STOCK TRAILERS 8'2"W 7'4"T

## STANDARD CONFIGURATION

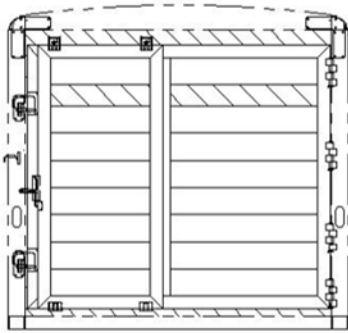

7'4" TALL STANDARD LIVESTOCK SLIDER  
REAR OPENING - 90 1/2" W X 84" T

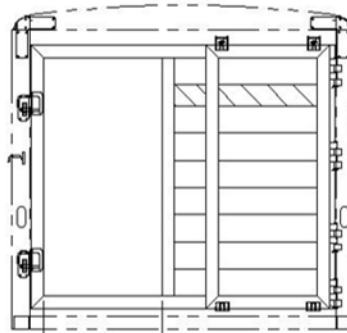

35  
PASS-THROUGH WIDTH  
STANDARD SLIDING REAR GATE  
SHOWN WITH ROLLER GATE OPEN

## OPTIONAL CONFIGURATIONS

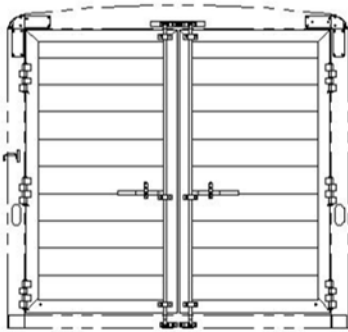

7'4" TALL DOUBLE DOOR  
REAR OPENING - 88 7/8" W X 83" T  
CAM LATCH WITH STANDARD HINGES

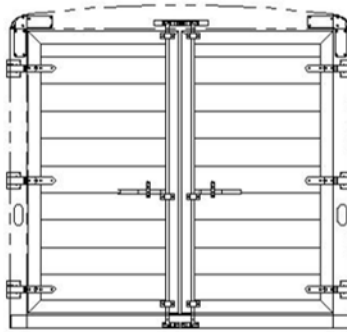

7'4" TALL DOUBLE DOOR  
REAR OPENING - 88 7/8" W X 83" T  
CAM LATCH WITH LAY-FLAT HINGES

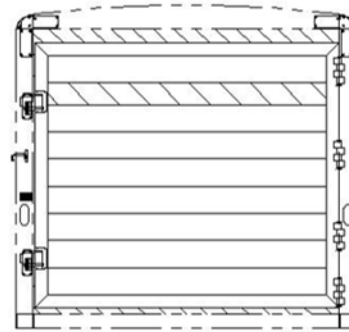

7'4" TALL SOLID GATE  
REAR OPENING - 90 1/2" W X 84" T

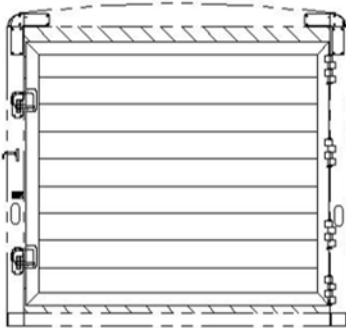

7'4" TALL ENCLOSED SOLID GATE  
REAR OPENING - 90 1/2" W X 84" T

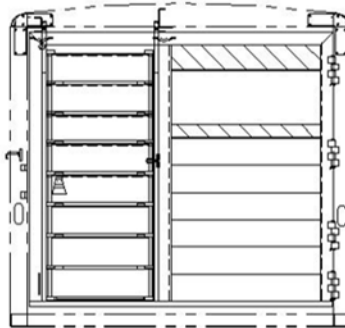

7'4" TALL HALF ROLL-UP, 32 1/4" OPENING WIDTH  
REAR OPENING - 90 1/2" W X 84" T

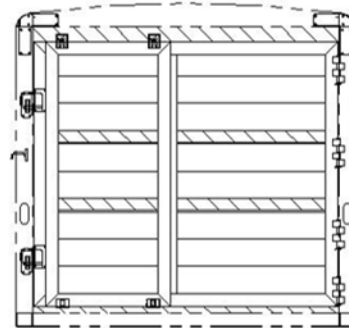

7'4" TALL SLOTTED ROLLER GATE  
REAR OPENING - 90 1/2" W X 84" T

ENDURA ALUMINUM TRAILER  
 7' X 16' (3) HORSE COMBO  
 6'8" / 7'4" TALL

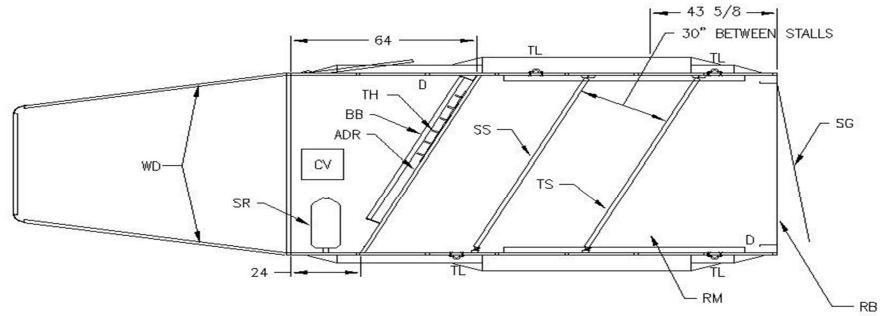

WD = 15 X 34 WINDOWS  
 D = DOME LIGHTS (2)  
 TL = TIE LOOPS (4) BOLT-ON  
 BB = BLANKET BAR  
 SG = SLIDING REAR GATE  
 SS = SLANT STALL DIVIDER  
 TS = TELESCOPING SLANT STALL DIVIDER

TH = TACK HOOKS  
 SR = 3 PEDESTAL SADDLE RACK FOR 3 HORSE  
 SR = 4 PEDESTAL SADDLE RACK FOR 4 HORSE  
 CV = CRANK-UP ROOF VENT  
 ADR = ANGLED DRESSING ROOM  
 RB = RUBBER BUMPER  
 RM = RUBBER MAT ON FLOOR

ENDURA ALUMINUM TRAILER  
 7' X 20' (4) HORSE COMBO  
 6'8" / 7'4" TALL

