

STANDARD EQUIPMENT

10 YEAR LIMITED WARRANTY
 Gooseneck w/ Tapered Nose, Padlock Securable Gates, 37" Wide Escape Door,
 2 - Double Wall Sliding Center Gate w/ Slam Latch ,
 Double Wall Sliding Rear Gate w/Posi-Latch, Rubber Rollers on Sliding Gates,
 Double Wall Smooth Extruded Sidewall, GN Compartment Fold Down Gate,
 52" High Solid Sides on 6'8" Tall / 60" on 7'4" Tall, Adjustable GN Hitch Height,
 Full Length Running Boards (7'5" Trailers Only), 2-5/16 Coupler, Rear Skid Plate,
 Rear Rubber Bumper, Spare Tire Rack, Spare Tire & Wheel for Standard Axle,
 Single 10K Spring Loaded Drop Leg Jack, Galvanized Subframe and A Frame Under GN
 T&G Aluminum Floor w/ Aggressive Traction Surface, 4" Aluminum I Beams
 62" Truck Clearance, Graphics Package, Conspicuity Tape, Wrap Around Latch Rear Gate,
 Heavy Duty Wiring Harness, Enclosed Brake Wiring, Safety Chains, One Piece Roof,
 Quick Change Pigtail, 7-Way Plug, High Mount LED Stop, Turn, & Tail Lights,
 Breakaway Battery w/ Charger & LED Dome Light (Switch on Light) in Front Compartment,
 LED Lights, Front ID Lights, Rubber Torsion Axles w/ Spindle Lube 8-Bolt Hubs,
 ST235/85R16 LR G Tires, 3-7K Axles w/ 12" x 2" Electric Brakes on 28'-34'
 3-8K Axles on 36'-40'



6'8" TALL

ITEM	Column1	Column2	AXLE	WEIGHT(LBS)	GVWR	REF#	LIST PRICE
ESTA000100	ES7.5-28-68 GN	ENDURA STOCK XD F/G	3-7K		25000	EN443NE56	\$ 44,748
ESTA000102	ES7.5-30-68 GN	ENDURA STOCK XD F/G	3-7K		25000	EN553NE91	\$ 46,222
ESTA000104	ES7.5-32-68 GN	ENDURA STOCK XD F/G	3-7K		25000	EN763NE26	\$ 47,696
ESTA000106	ES7.5-34-68 GN	ENDURA STOCK XD F/G	3-7K		25000	EN873NE62	\$ 49,171
ESTA000108	ES7.5-36-68 GN	ENDURA STOCK XD F/G	3-8K		25000	EN734NE07	\$ 56,762
ESTA000110	ES7.5-38-68 GN	ENDURA STOCK XD F/G	3-8K		25000	EN844NE43	\$ 58,238
ESTA000112	ES7.5-40-68 GN	ENDURA STOCK XD F/G	3-8K		25000	EN954NE78	\$ 59,712

7'4" TALL

ITEM	Column1	Column2	AXLE	WEIGHT(LBS)	GVWR	REF#	LIST PRICE
ESTA000120	ES7.5-28-74 GN	ENDURA STOCK XD F/G	3-7K		25000	EN663NE82	\$ 47,639
ESTA000122	ES7.5-30-74 GN	ENDURA STOCK XD F/G	3-7K		25000	EN873NE17	\$ 49,113
ESTA000124	ES7.5-32-74 GN	ENDURA STOCK XD F/G	3-7K		25000	EN983NE52	\$ 50,587
ESTA000126	ES7.5-34-74 GN	ENDURA STOCK XD F/G	3-7K		25000	EN004NE88	\$ 52,062
ESTA000128	ES7.5-36-74 GN	ENDURA STOCK XD F/G	3-8K		25000	EN954NE33	\$ 59,653
ESTA000130	ES7.5-38-74 GN	ENDURA STOCK XD F/G	3-8K		25000	EN074NE69	\$ 61,129
ESTA000132	ES7.5-40-74 GN	ENDURA STOCK XD F/G	3-8K		25000	EN284NE04	\$ 62,603

STANDARD EQUIPMENT

10 YEAR LIMITED WARRANTY

Gooseneck w/ Tapered Nose, Padlock Securable Gates, 37" Wide Escape Door, 2 - Double Wall Sliding Center Gate w/ Slam Latch, Double Wall Sliding Rear Gate w/Posi-Latch, Rubber Rollers on Sliding Gates, Double Wall Smooth Extruded Sidewall, GN Compartment Fold Down Gate, 52" High Solid Sides on 6'8" Tall / 60" on 7'4" Tall, Adjustable GN Hitch Height, 2-5/16 Coupler, Rear Skid Plate, Galvanized Subframe and A Frame Under GN T&G Aluminum Floor w/ Aggressive Traction Surface, 4" Aluminum I Beams Rear Rubber Bumper, Spare Tire Rack, Spare Tire & Wheel for Standard Axle, Single 10K Spring Loaded Drop Leg Jack, Flat Floor w/ Traction Surface, 62" Truck Clearance, Graphics Package, Conspicuity Tape, Wrap Around Latch Rear Gate, Heavy Duty Wiring Harness, Enclosed Brake Wiring, Safety Chains, One Piece Roof, Quick Change Pigtail, 7-Way Plug, High Mount LED Stop, Turn, & Tail Lights, Breakaway Battery w/ Charger & LED Dome Light (Switch on Light) in Front Compartment, LED Lights, Front ID Lights, Rubber Torsion Axles w/ Spindle Lube 8-Bolt Hubs, ST235/85R16 LR G Tires, 3-7K Axles w/ 12" x 2" Electric Brakes on 28'-34' 3-8K Axles on 36'-40'



6'8" TALL

ITEM	Column1	Column2	AXLE	WEIGHT(LBS)	GVWR	REF#	LIST PRICE
ESTA000140	ES8-28-68 GN	ENDURA STOCK XD F/G	3-7K		25000	EN853NE14	\$ 46,512
ESTA000142	ES8-30-68 GN	ENDURA STOCK XD F/G	3-7K		25000	EN963NE49	\$ 47,986
ESTA000144	ES8-32-68 GN	ENDURA STOCK XD F/G	3-7K		25000	EN083NE84	\$ 49,460
ESTA000146	ES8-34-68 GN	ENDURA STOCK XD F/G	3-7K		25000	EN293NE19	\$ 50,934
ESTA000148	ES8-36-68 GN	ENDURA STOCK XD F/G	3-8K		25000	EN054NE65	\$ 58,526
ESTA000150	ES8-38-68 GN	ENDURA STOCK XD F/G	3-8K		25000	EN264NE01	\$ 60,001
ESTA000152	ES8-40-68 GN	ENDURA STOCK XD F/G	3-8K		25000	EN374NE36	\$ 61,475

7'4" TALL

ITEM	Column1	Column2	AXLE	WEIGHT(LBS)	GVWR	REF#	LIST PRICE
ESTA000160	ES8-28-74 GN	ENDURA STOCK XD F/G	3-7K		25000	EN083NE40	\$ 49,403
ESTA000162	ES8-30-74 GN	ENDURA STOCK XD F/G	3-7K		25000	EN193NE75	\$ 50,877
ESTA000164	ES8-32-74 GN	ENDURA STOCK XD F/G	3-7K		25000	EN304NE10	\$ 52,351
ESTA000166	ES8-34-74 GN	ENDURA STOCK XD F/G	3-7K		25000	EN414NE45	\$ 53,825
ESTA000168	ES8-36-74 GN	ENDURA STOCK XD F/G	3-8K		25000	EN274NE91	\$ 61,417
ESTA000170	ES8-38-74 GN	ENDURA STOCK XD F/G	3-8K		25000	EN484NE27	\$ 62,892
ESTA000172	ES8-40-74 GN	ENDURA STOCK XD F/G	3-8K		25000	EN594NE62	\$ 64,366

ENDURA STOCK AXLE/BRAKE/TIRE OPTIONS

OPTIONS FOR (3) 7K RUBBER TORSION AXLES W/ST235/85R16 LRG TIRES

ITEM			REF#	LIST PRICE
X9138	8K AXLE (3), RUBBER TORSION ILOS (3)7K	ST235/85R16 LRG, 25000 GVWR	AL620SO52	\$ 3,444
X9139	10K AXLE (3), RUBBER TORSION ILOS (3)7K	235/75R17.5 LRJ, 35900 GVWR	AL260SO95	\$ 8,175
X9068	8K AXLES (2), RUBBER TORSION ILOS (3)7K	ST235/85R16 LRG, 17500 GVWR	AL400SO20	\$ 545
X9132	8K AXLES (2) ILOS (3)7K AXLES	235/75R17.5 LRJ, 17500 GVWR	AL220SO05	\$ 2,864
X9069	10K AXLES (2), RUBBER TORSION ILOS (3)7K	235/75R17.5 LRJ, 35900 GVWR	AL930SO35	\$ 5,110

OPTIONS FOR (3) 8K RUBBER TORSION AXLES W/ST235/85R16 LRG TIRES

ITEM			REF#	LIST PRICE
X9141	10K AXLES (3), RUBBER TORSION ILOS (3)8K	235/75R17.5 LRJ, 35900 GVWR	AL630SO44	\$ 4,732
<i>*Trailers with triple 10K axles have a higher than 26,000# hauling capacity and will need to be charged FET(Federal Excise Tax)</i>				

BRAKES

ITEM			REF#	LIST PRICE
X9070	ELECTRIC/HYDRAULIC BRAKES, ILOS 2 ELECT		BR820BR65	\$ 3,721
X9071	ELECTRIC/HYDRAULIC BRAKES, ILOS 3 ELECT		BR230BR45	\$ 4,214

TIRE/WHEEL OPTIONS (ILOS)

ITEM			REF#	LIST PRICE
X9072	T/W ST235/85R 16 LR G ILOS 16E	Westlake	AL100SO69	\$ 219
X9074	T/W 235/75R 17.5 LR J ILOS 16E	Westlake	AL200SO85	\$ 370
X9142	T/W 235/75R 17.5 LR J ILOS 16G	Westlake	AL100SO15	\$ 149

TIRE/WHEEL OPTIONS (ADDITIONAL SPARE)

ITEM			REF#	LIST PRICE
234294	TIRE & WHEEL ST235/80R16E W/SL MOD LION	Castle Rock	TI200WH04	\$ 265
234296	TIRE & WHEEL ST235/85R16G W/SL MOD LION	Westlake	TI300WH42	\$ 444
234398	TIRE & WHEEL 235/75R17.5J W/SL MOD LION	Westlake	TI400WH82	\$ 626
X9076	ALUMINUM SPOKE T/W ILOS 16" WHEEL	<i>*price per wheel</i>	AL200SO09	\$ 271
X9075	ALUM WHEEL ILOS 17.5 J WHEEL	<i>*price per wheel</i>	AL200SO09	\$ 271

ENDURA STOCK ACCESSORIES AND OPTIONS

BODY & FRAME OPTIONS

ITEM			REF#	LIST PRICE
X9003	3" SLOTTED SIDES (28" FROM FLOOR)	<i>per Trailer</i>	AL200SO22	\$ 288
X9001	FRONT VENT & COVER		AL300SO46	\$ 449
X9004	TIE RAIL (INSIDE OR OUTSIDE)	<i>per ft.</i>	AL000SO26	\$ 34
231744	TIE LOOP CAST AL	<i>Bolt-On, External (price each)</i>	MI000 P40	\$ 52
89321	TIE LOOP, 1/2" AL ROUND X 7-1/2"	<i>Weld-On, Internal (price each)</i>	AL000 P23	\$ 30
X9007	DUAL JACK, SINGLE SPEED ILOS	<i>Gooseneck Only</i>	AL300SO27	\$ 425
X9008	DUAL JACK, 2 SPD GEARBOX ILOS	<i>Gooseneck Only</i>	AL600SO76	\$ 878
X9009	12K ELECT/HYD BIG FOOT JACK ILOS	<i>Gooseneck Only, Includes Battery</i>	AL620SO58	\$ 3,452

ESCAPE DOOR & SIDE RAMP OPTIONS (14,500 GVWR)-Restrictions may apply to placement

ITEM			REF#	LIST PRICE
X9016	ADDITIONAL 37" ESCAPE DOOR, EITHER SIDE		AL700SO69	\$ 999
X9127	52" WIDE ESCAPE DOOR, ADDITIONAL		AL010SO23	\$ 1,329
X9013	52" WIDE ESCAPE DOOR ILOS		AL200SO62	\$ 340
X9128	52" WIDE ESCAPE DOOR, NO SILL, ILOS 37"		AL110SO22	\$ 1,457
X9129	52" WIDE ESCAPE DOOR, NO SILL, ADD		AL810SO85	\$ 2,448
X9015	52" WIDE FOLD DOWN SIDE RAMP		AL220SO19	\$ 2,882
X9014	52" WIDE FOLD DOWN SIDE RAMP ILOS		AL410SO59	\$ 1,895
X9130	52"W FOLD DOWN SIDE RAMP, NO SILL, ADD		AL030SO79	\$ 3,999
X9131	52"W FOLD DOWN SIDE RAMP, NO SILL, ILOS		AL320SO20	\$ 3,013
X9017	FULLY ENCLSD LIVESTOCK ESCAPE DOOR ILOS		AL100SO53	\$ 199

CENTER GATE OPTIONS

ITEM			REF#	LIST PRICE
X9020	DELETE SLIDING CENTER GATE & POSTS		AL00-SO73	\$ (573)
X9021	MOVE CENTER GATE FROM STANDARD POSITION		AL200SO08	\$ 270
X9022	ADJ SOLID CNTR GATE ILOS, NO SLIDER		AL310SO30	\$ 1,727
X9023	ADJ SOLID CNTR GATE, NO SLIDER		AL620SO55	\$ 3,448
X9134	ADJ SLIDING CNTR GATE ILOS		AL510SO64	\$ 2,031
x9133	ADJ SLIDIING CNTR GATE		AL820SO88	\$ 3,751
X9002	ADD SLIDING CENTER GATE		AL310SO27	\$ 1,723
X9024	SOLID CENTER GATE ILOS		AL000SO00	\$ -
X9025	ADDITIONAL SOLID CENTER GATE		AL110SO28	\$ 1,465
X9026	ADDITIONAL SET OF CENTER GATE POSTS		AL400SO52	\$ 587
X9027	3" SLOT IN CENTER GATE		AL000SO86	\$ 112
X9140	PEN (1 PAIR, 4' LONG)		AL310SO94	\$ 1,810

REAR GATE OPTIONS (ILOS)

ITEM			REF#	LIST PRICE
X9028	SOLID REAR GATE (NON-SLIDING)	<i>w/ Standard L.S. Opening</i>	AL000SO00	\$ -
X9029	ENCLOSED SOLID (NON-SLIDING) REAR GATE		AL000SO00	\$ -
X9030	1/2 ROLL-UP DOOR IN LIVESTOCK REAR GATE		AL700SO18	\$ 932
X9031	3" SLOT IN REAR GATE		AL000SO86	\$ 112
X9032	DOUBLE REAR DOORS WITH CAM LATCH		AL200SO57	\$ 334
X9033	DBL REAR DOORS W/ FOLD AROUND HINGES	<i>Lay Flat Hinges</i>	AL600SO64	\$ 862
X9137	4' REAR RAMP BEHIND REAR GATE		AL520SO87	\$ 3,360

GN COMPARTMENT GATES & DOORS				
ITEM			REF#	LIST PRICE
X9010	GN SLAM DOOR W/ LOCK	Available on Both Sides	AL400SO28	\$ 556
X9011	WINDOW IN GOOSENECK COMPARTMENT 15X34	Available on Both Sides	AL200SO53	\$ 329
X9012	GN SLAM DOOR WITH LOCK ON FRONT OF NOSE	Drop Down	AL600SO64	\$ 862
X9018	EZ STORE RAMPS ILOS FOLD DOWN GN GATE		AL300SO25	\$ 422

DOUBLE DECK OPTIONS				
ITEM			REF#	LIST PRICE
X9036	DOUBLE DECK RAIL, PER FT. OF TRAILER		AL000SO37	\$ 48
X9037	SPLIT SLIDING CENTER GATE ILOS		AL500SO75	\$ 747
X9038	SPLIT SLIDING REAR GATE ILOS		AL500SO75	\$ 747
X9039	SPLIT ESCAPE DOOR		AL100SO66	\$ 216
X9040	DOUBLE DECK FLOORING, 7' WIDTH, PER FT	weight rating 70lbs per sqft per ft	AL100SO25	\$ 162
X9041	DOUBLE DECK FLOORING, 8' WIDTH, PER FT	weight rating 70lbs per sqft per ft	AL100SO39	\$ 181
** weight rating 70lbs per sqft per ft				

LIGHTING OPTIONS				
ITEM			REF#	LIST PRICE
X9042	LED LOADING LIGHT - REQUIRES SWITCH	1900 Lumens	AL100SO58	\$ 205
X9043	RECESSED TOGGLE SWITCH - DOME OR LOAD		AL000SO53	\$ 69
X9045	EXTRA LED CLEARANCE LIGHTS (PER PAIR)		AL000SO62	\$ 81
X9046	RECESSED 3 WAY TOGGLE SWITCH	Requires 2	AL000SO66	\$ 86
X9047	LED BACK UP LIGHTS (PER PAIR)		AL300SO27	\$ 425
X9048	LED DOME LIGHT		AL000SO66	\$ 86

VENTS				
ITEM			REF#	LIST PRICE
X9049	CRANK-UP ROOF VENT		AL100SO64	\$ 213
X9050	DRAFT/EXHAUST (POP-UP) ROOF VENT		AL100SO51	\$ 196

RUBBER MAT (Add rubber matting cost and installation cost)				
ITEM			REF#	LIST PRICE
X9051	1/2"X60"X84" RUBBER MATTING	per Sheet	AL100SO61	\$ 209
X9052	3/4"X60"X84" RUBBER MATTING	per Sheet	AL100SO91	\$ 248
X9053	INSTALLATION OF MATTING FOR 7.0' TRAILER		AL200SO00	\$ 260
X9054	INSTALLATION OF MATTING FOR 7.5' AND 8.0		AL300SO17	\$ 412

PLEXI-GLASS & STORAGE				
ITEM			REF#	LIST PRICE
91899	ENDURA PLEXIGLASS HARDWARE KIT		KI100KI31	\$ 170
233851	PLEXIGLASS STRIP 3/16 X 7-3/16 X 96 BRNZ	Sold in 8' Lengths	MI000 P59	\$ 77
X9035	PLEXI-GLASS INSTALLED AT HILLSBORO	per ft.	AL000SO69	\$ 90
X9034	PLEXI-GLASS STORAGE TRAY	GN or Straight Hitch Trailer	AL400SO18	\$ 543
** Plexi-Glass Install Kit Includes: 50 retention plugs, 14 filler end pieces, 1 drill guide, and installation instructions				
*** Plexi-Glass Installed per foot of trailer, Includes 2 slots left side, 2 slots right side, escape door & rear gate				
****Pricing = MSRP * Length(feet) of Trailer, Includes 2 slots left side, 2 slots right side, escape door & rear gate				

COMBO ROOF COVE & GOOSENECK NOSE BLACK				
ITEM			REF#	LIST PRICE
X9056	(1) PAINT ROOF COVE - BLACK	(Trailer + Nose Length) * MSRP = Price	AL000SO38	\$ 49
X9057	(2) PAINT GOOSENECK NOSE BLACK	Includes Nose and Sides	AL500SO20	\$ 675
** example (1)+(2) :7x20+8' nose = (28 ft total trailer x \$49= \$1372)+(\$675) = \$2047				

PAINT ROOF COVE /ft of total trailer length (include gooseneck & 2' V-Nose)				
ITEM			REF#	LIST PRICE
X9055	PAINT ROOF COVE - BLACK	(Trailer + Nose Length) * MSRP = Price	AL000SO38	\$ 49
** Example: SH 7x18 + 2' v-Nose = 20 ft total trailer X \$49 = \$980				

ENDURA LIVESTOCK AND COMBO OPTIONS

BODY & FRAME OPTIONS

ITEM	Column2	Column3	Column4	Column5	Column6	REF#	LIST PRICE
X9077	FULLY ENCLOSE SIDE (PER FT)				per ft./ per side	AL000SO67	\$ 87

DRESSING ROOM OPTIONS (d/r)

ITEM	Column2	Column3	Column4	Column5	Column6	REF#	LIST PRICE
X9078	ANGLED D/R W/ SEALED DOOR, 2; SHORT WALL				Deletes Escape Door	AL710SO09	\$ 2,219
X9079	4' RECTANGULAR D/R W/ SEALED D/R DOOR				Deletes Escape Door	AL710SO09	\$ 2,219
X9080	SLIDE OUT CAMPER STEP - D/R DOOR				N/A on 8' W Trailer	AL200SO69	\$ 349
X9081	SADDLE RACK, 2 PEDESTAL					AL500SO30	\$ 688
X9082	SADDLE RACK, 3 PEDESTAL					AL600SO53	\$ 848
X9083	SADDLE RACK, 4 PEDESTAL					AL700SO81	\$ 1,014
X9084	TACK HOOKS, BAR OF 6					AL000SO76	\$ 99
X9085	BRUSH TRAY - SPECIFY PLACEMENT					AL000SO80	\$ 104
X9086	BLANKET BAR					AL000SO66	\$ 86
X9088	WALK THROUGH DOOR FROM D/R TO LIVESTOCK					AL600SO94	\$ 901

LIVESTOCK/HORSE COMPARTMENT OPTIONS

ITEM	Column2	Column3	Column4	Column5	Column6	REF#	LIST PRICE
X9089	SLANT STALL DIVIDER, PADDED					AL800SO19	\$ 1,064
X9090	SLANT STALL DIVIDER, PADDED, TELESCOPING					AL110SO36	\$ 1,475
X9091	FULL SLANT STALL DIVIDER/STUD GATE ILOS					AL110SO15	\$ 1,448
X9092	PADDING ON LIVESTOCK SIDE OF ANGLE WALL					AL100SO04	\$ 135
X9093	KICK PANEL - RUBBER 48" HEIGHT				Head Side, per ft.	AL000SO74	\$ 96
94263	BOLT-ON TIE LOOP PACKAGE				External (price each)	EN000NE40	\$ 52
89321	TIE LOOP, 1/2" AL ROUND X 7-1/2"				Weld-On, Internal (price each)	AL000 P23	\$ 30
X9004	TIE RAIL (INSIDE OR OUTSIDE)				per ft.	AL000SO26	\$ 34

WINDOWS

ITEM	Column2	Column3	Column4	Column5	Column6	REF#	LIST PRICE
X9011	WINDOW IN GOOSENECK COMPARTMENT 15X34				Available on Both Sides	AL200SO53	\$ 329
X9095	SIDE WINDOW 14X21					AL200SO18	\$ 283

ENDURA PAINT & POLISH OPTIONS

GREEN = PAINT

OPTION 1: PAINT ROOF COVE BLACK
INCLUDES SIDES AND FRONT

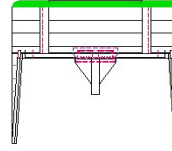
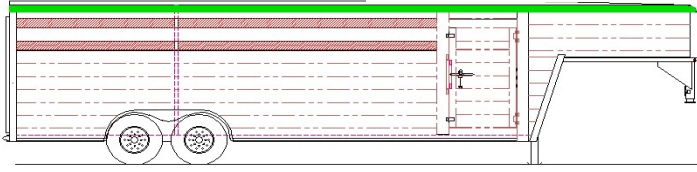

OPTION 2: PAINT NOSE BLACK
INCLUDES SIDES AND FRONT

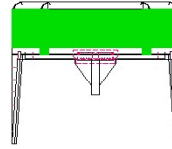
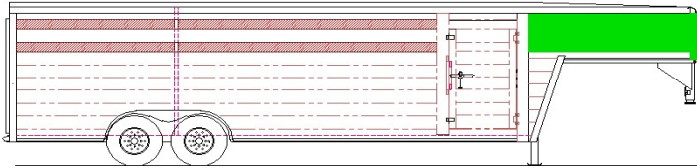

OPTION 3: PAINT ROOF COVE AND NOSE BLACK
COMBINE COST OF OPTION 1 AND OPTION 2 FOR DEALER COST

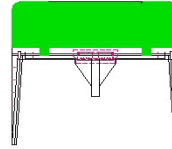
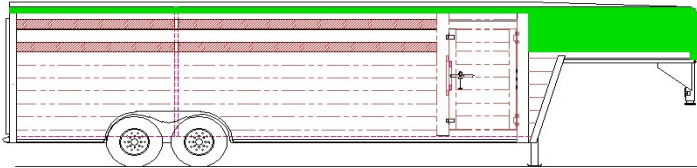

TITLE						<i>Hillsboro Industries</i> 220 Industrial Road Hillsboro, KS 67063		1-800-835-0209 hi@hillsboroindustries.com www.hillsboroindustries.com	
PAINT OPTIONS									
DWG NO.	REV	DATE	DRAWN BY	SCALE	PAGE				
	A	12-7-16	APD	1/60					

ENDURA STOCK TRAILERS 7'6"W CENTER GATE PASS-THROUGH WIDTH

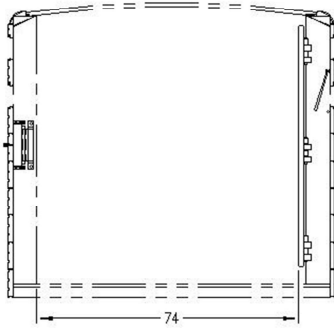

PASS-THROUGH WIDTH
W/ 6K, 7K OR 7.2K AXLES
SHOWN WITH CENTER GATE OPEN

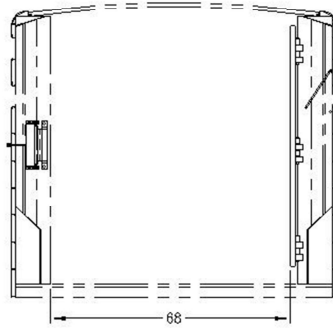

PASS-THROUGH WIDTH
W/ 8K AXLES
SHOWN WITH CENTER GATE OPEN

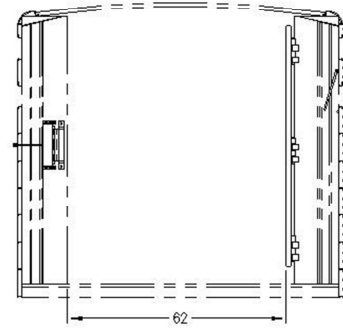

PASS-THROUGH WIDTH
W/ 10K AXLES
SHOWN WITH CENTER GATE OPEN

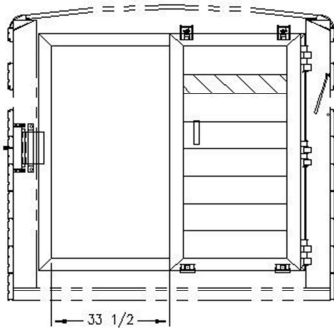

PASS-THROUGH WIDTH
W/ 6K, 7K OR 7.2K AXLES
SHOWN WITH ROLLER DOOR OPEN

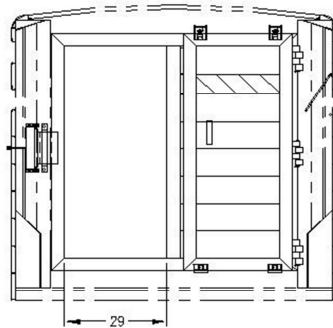

PASS-THROUGH WIDTH
W/ 8K AXLES
SHOWN WITH ROLLER DOOR OPEN

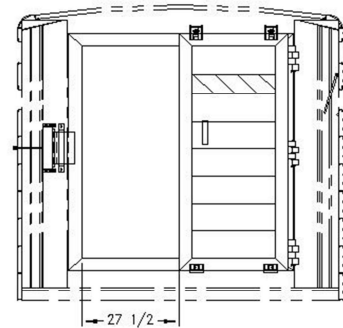

PASS-THROUGH WIDTH
W/ 10K AXLES
SHOWN WITH ROLLER DOOR OPEN

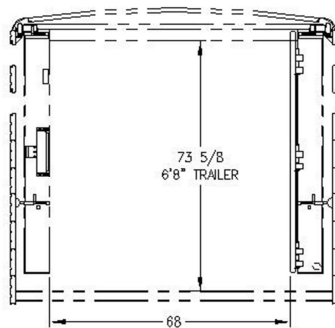

PASS-THROUGH DIMENSIONS
ADJUSTABLE POSITION CENTER GATE

ENDURA STOCK TRAILERS 8'2"W CENTER GATE PASS-THROUGH WIDTH

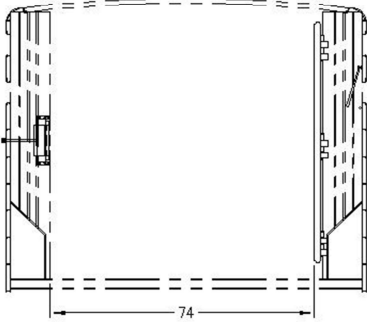

PASS-THROUGH WIDTH
W/ 6K, 7K OR 7.2K AXLES
SHOWN WITH CENTER GATE OPEN

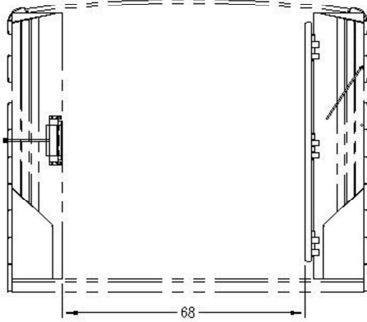

PASS-THROUGH WIDTH
W/ 8K AXLES
SHOWN WITH CENTER GATE OPEN

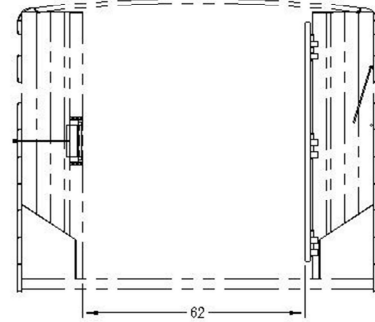

PASS-THROUGH WIDTH
W/ 10K AXLES
SHOWN WITH CENTER GATE OPEN

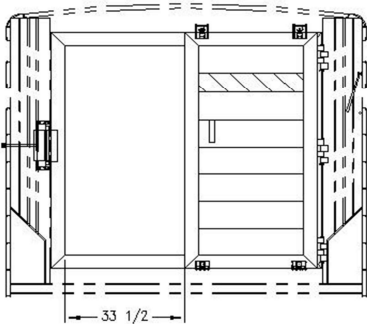

PASS-THROUGH WIDTH
W/ 6K, 7K OR 7.2K AXLES
SHOWN WITH CENTER GATE OPEN

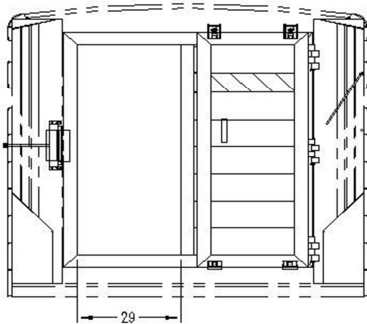

PASS-THROUGH WIDTH
W/ 8K AXLES
SHOWN WITH CENTER GATE OPEN

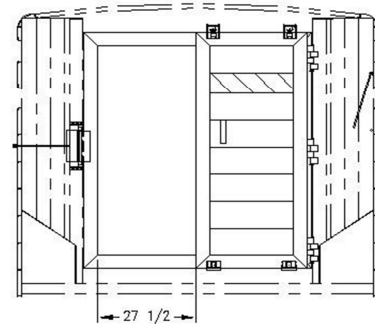

PASS-THROUGH WIDTH
W/ 10K AXLES
SHOWN WITH CENTER GATE OPEN

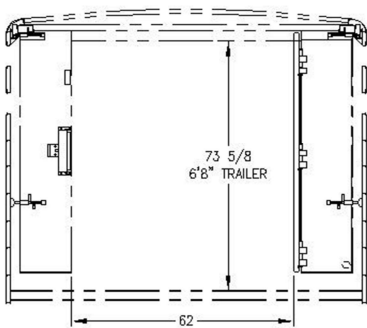

73 5/8
6'8" TRAILER

PASS-THROUGH DIMENSIONS
ADJUSTABLE POSITION CENTER GATE

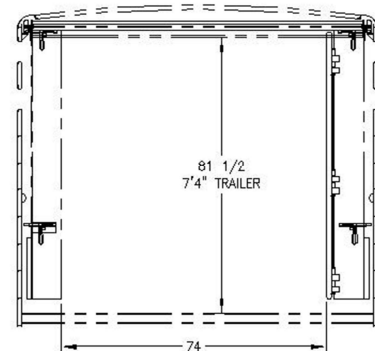

81 1/2
7'4" TRAILER

REAR GATE CONFIGURATIONS, ENDURA STOCK TRAILERS 7'6"W 6'8"T

STANDARD CONFIGURATION

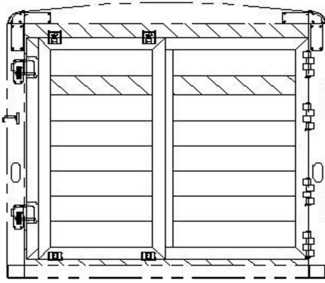

6'8" TALL, STANDARD LIVESTOCK SLIDER
REAR OPENING - 82W X 76T

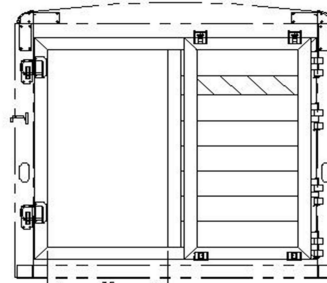

35
PASS-THROUGH WIDTH
STANDARD SLIDING REAR GATE
SHOWN WITH ROLLER GATE OPEN

OPTIONAL CONFIGURATIONS

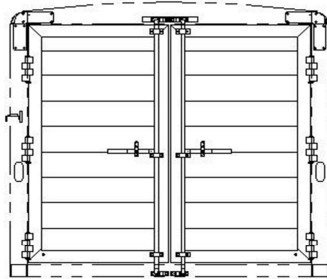

6'8" TALL, DOUBLE DOORS
REAR OPENING - 88 7/8W X 75T
CAM LATCH WITH STANDARD HINGES

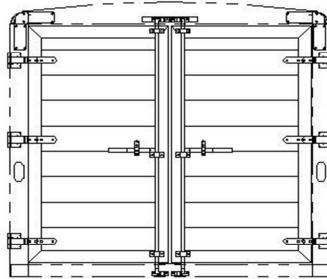

6'8" TALL, DOUBLE DOOR
REAR OPENING - 88 7/8W X 75T
CAM LATCH WITH LAY-FLAT HINGES

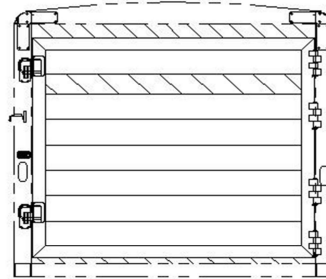

6'8" TALL, SOLID GATE
REAR OPENING - 82W X 76T

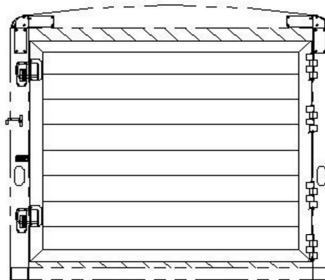

6'8" TALL, ENCLOSED SOLID GATE
REAR OPENING - 82W X 76T

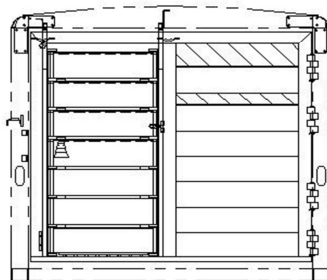

6'8" TALL, HALF ROLL-UP, 32 1/4" OPENING WIDTH
REAR OPENING - 82W X 76T

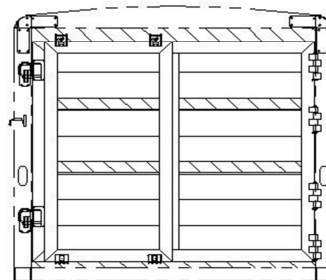

6'8" TALL, SLOTTED ROLLER GATE
REAR OPENING - 82W X 76T

REAR GATE CONFIGURATIONS, ENDURA STOCK TRAILERS 7'6"W 7'4"T

STANDARD CONFIGURATION

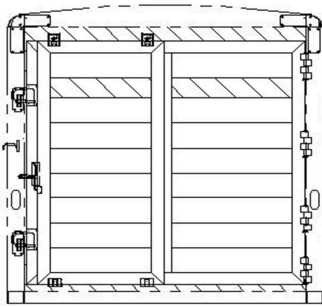

7'4" TALL, STANDARD LIVESTOCK SLIDER
REAR OPENING - 82W X 84T

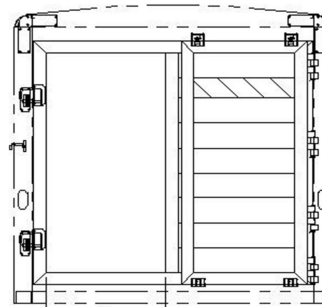

PASS-THROUGH WIDTH
STANDARD SLIDING REAR GATE
SHOWN WITH ROLLER GATE OPEN

OPTIONAL CONFIGURATIONS

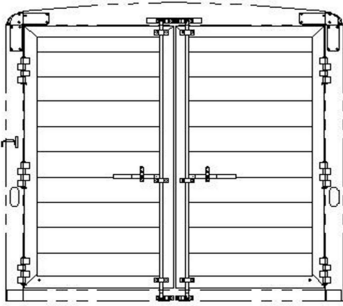

7'4" TALL, DOUBLE DOOR
REAR OPENING - 88 7/8W X 83T
CAM LATCH WITH STANDARD HINGES

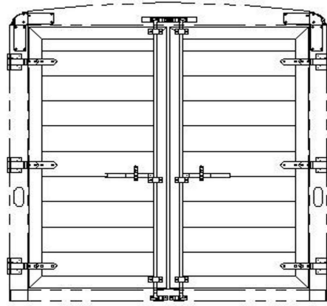

7'4" TALL, DOUBLE DOOR
REAR OPENING - 88 7/8W X 83T
CAM LATCH WITH LAY-FLAT HINGES

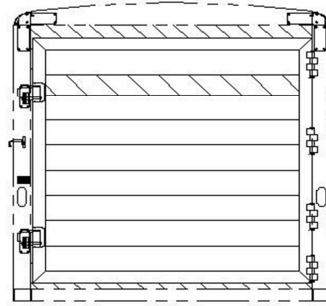

7'4" TALL, SOLID GATE
REAR OPENING - 82W X 84T

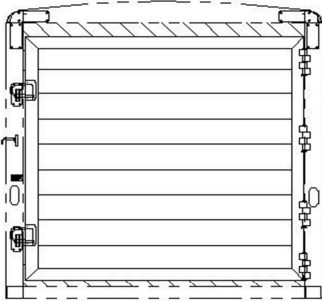

7'4" TALL, ENCLOSED SOLID GATE
REAR OPENING - 82W X 84T

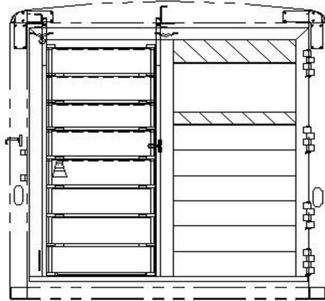

7'4" TALL, HALF ROLL-UP, 32 1/4" OPENING WIDTH
REAR OPENING - 82W X 84T

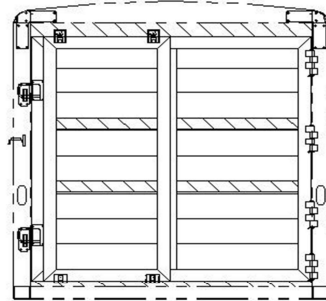

7'4" TALL, SLOTTED ROLLER GATE
REAR OPENING - 82W X 84T

REAR GATE CONFIGURATIONS, ENDURA STOCK TRAILERS 8'2"W 6'8"T

STANDARD CONFIGURATION

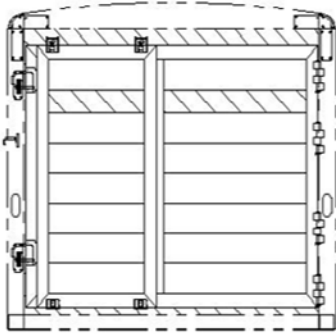

6'8" TALL, STANDARD LIVESTOCK SLIDER
REAR OPENING - 90 1/2" X 76"

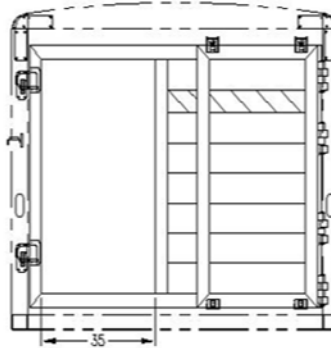

35
PASS-THROUGH WIDTH
STANDARD SLIDING REAR GATE
SHOWN WITH ROLLER GATE OPEN

OPTIONAL CONFIGURATIONS

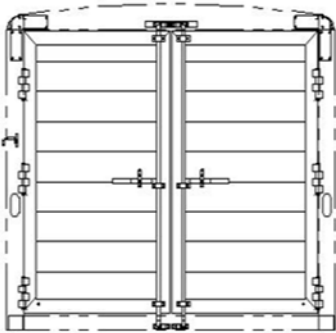

6'8" TALL DOUBLE DOORS
REAR OPENING - 88 7/8" X 75"
CAM LATCH WITH STANDARD HINGES

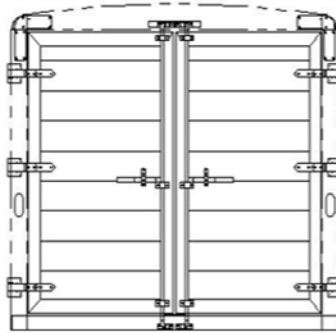

6'8" TALL DOUBLE DOOR
REAR OPENING - 88 7/8" X 75"
CAM LATCH WITH LAY-FLAT HINGES

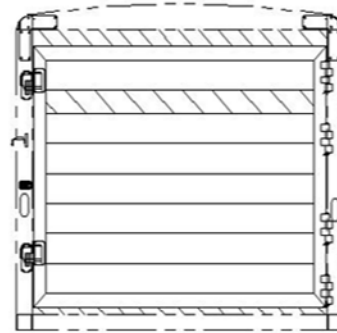

6'8" TALL SOLID GATE
REAR OPENING - 90 1/2" X 76"



6'8" TALL, ENCLOSED SOLID GATE
REAR OPENING - 90 1/2" X 76"

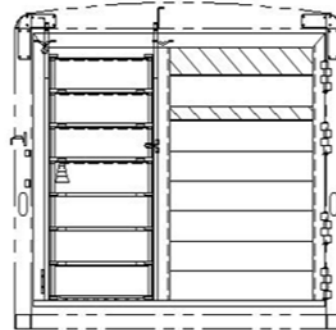

6'8" TALL, HALF ROLL-UP, 32 1/4" OPENING WIDTH
REAR OPENING - 90 1/2" X 76"

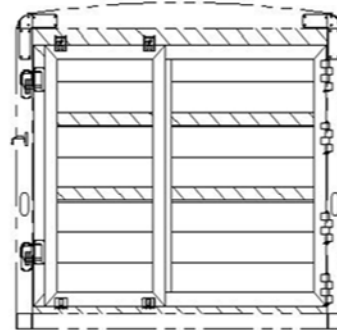

6'8" TALL, SLOTTED ROLLER GATE
REAR OPENING - 90 1/2" X 76"

REAR GATE CONFIGURATIONS, ENDURA STOCK TRAILERS 8'2"W 7'4"T

STANDARD CONFIGURATION

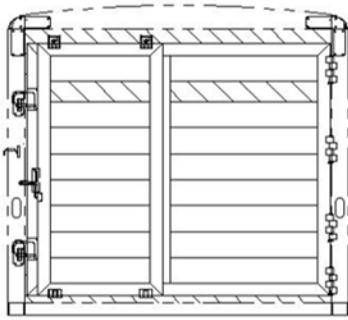

7'4" TALL, STANDARD LIVESTOCK SLIDER
REAR OPENING - 90 1/2" W X 84" T

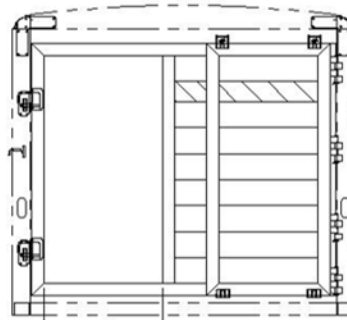

PASS-THROUGH WIDTH
STANDARD SLIDING REAR GATE
SHOWN WITH ROLLER GATE OPEN

OPTIONAL CONFIGURATIONS

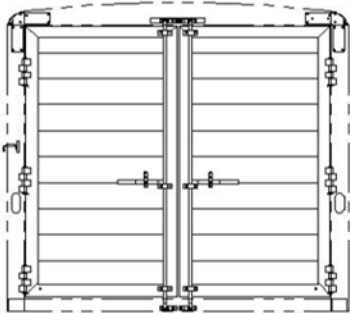

7'4" TALL, DOUBLE DOOR
REAR OPENING - 88 7/8" W X 83" T
CAM LATCH WITH STANDARD HINGES

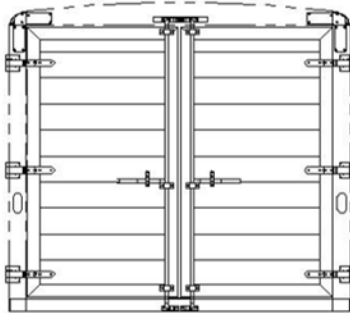

7'4" TALL, DOUBLE DOOR
REAR OPENING - 88 7/8" W X 83" T
CAM LATCH WITH LAY-FLAT HINGES

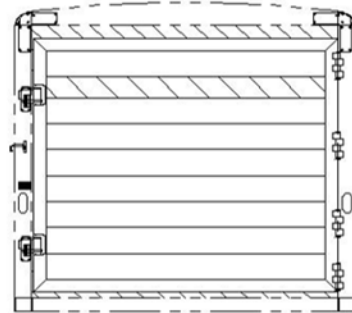

7'4" TALL, SOLID GATE
REAR OPENING - 90 1/2" W X 84" T

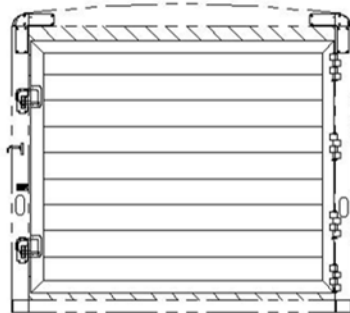

7'4" TALL, ENCLOSED SOLID GATE
REAR OPENING - 90 1/2" W X 84" T

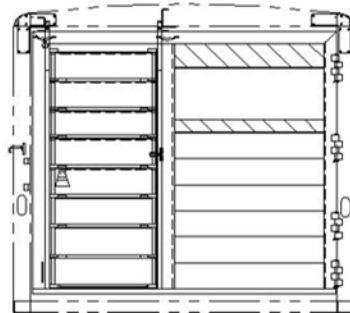

7'4" TALL, HALF ROLL-UP, 32 1/4" OPENING WIDTH
REAR OPENING - 90 1/2" W X 84" T

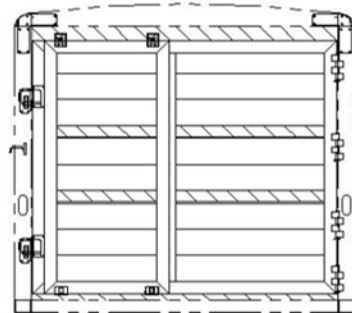

7'4" TALL, SLOTTED ROLLER GATE
REAR OPENING - 90 1/2" W X 84" T

ENDURA ALUMINUM TRAILER
 7' X 16', (3) HORSE COMBO
 6'8"/7'4" TALL

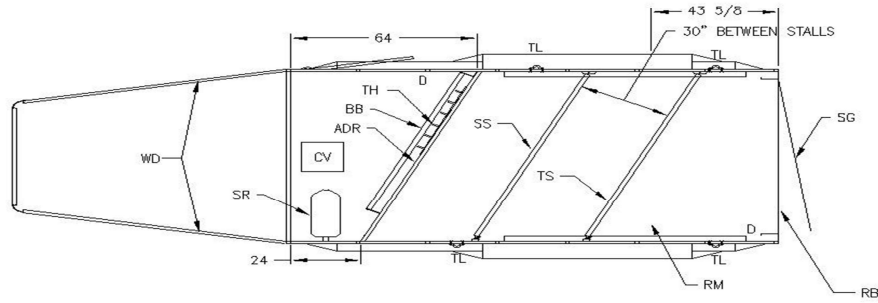

WD = 15 X 34 WINDOWS
 D = DOME LIGHTS (2)
 TL = TIE LOOPS (4) BOLT-ON
 BB = BLANKET BAR
 SG = SLIDING REAR GATE
 SS = SLANT STALL DIVIDER
 TS = TELESCOPING SLANT STALL DIVIDER

TH = TACK HOOKS
 SR = 3 PEDESTAL SADDLE RACK FOR 3 HORSE
 SR = 4 PEDESTAL SADDLE RACK FOR 4 HORSE
 CV = CRANK-UP ROOF VENT
 ADR = ANGLED DRESSING ROOM
 RB = RUBBER BUMPER
 RM = RUBBER MAT ON FLOOR

ENDURA ALUMINUM TRAILER
 7' X 20', (4) HORSE COMBO
 6'8"/7'4" TALL

