

STANDARD EQUIPMENT

Horizontal Double Wall Construction
 Smooth Interior & Exterior Finish
 Two Air Spaces That Are Plexiglass Ready
 One Interior Partition & Two Compartments on 44x60
 Two Interior Partitions & Three Compartments on 48X72
 Slam Latch on Center Cross Partition
 Double Rear Doors



44 X 60 BOX

ITEM			WEIGHT(LBS)	REF#	LIST PRICE
67000	SB44-60-43 STOCK	Base ITEM	230	AL710NE61	\$ 2,287
67000-001	SB44-60-43 STOCK	w/ Plexiglass installed		AL020NE32	\$ 2,639
67000-002	SB44-60-43 STOCK	w/ Lights installed		AL020NE70	\$ 2,688
67000-003	SB44-60-43 STOCK	w/ Plexiglass & Lights installed		AL320NE44	\$ 3,044

48 X 72 BOX

ITEM			WEIGHT(LBS)	REF#	LIST PRICE
67001	SB48-72-43 STOCK	Base ITEM	285	AL120NE08	\$ 2,738
67001-001	SB48-72-43 STOCK	w/ Plexiglass installed		AL420NE09	\$ 3,129
67001-002	SB48-72-43 STOCK	w/ Lights installed		AL420NE15	\$ 3,136
67001-003	SB48-72-43 STOCK	w/ Plexiglass & Lights installed		AL720NE17	\$ 3,529

STOCK BOX OPTIONS

ITEM			REF#	LIST PRICE
67186	Plexiglass Kit for 44 x 60 Boxes, Dealer Installed		KI100KI79	\$ 232
67174	Plexiglass Kit for 48 x 72 Boxes, Dealer Installed		KI200KI07	\$ 269

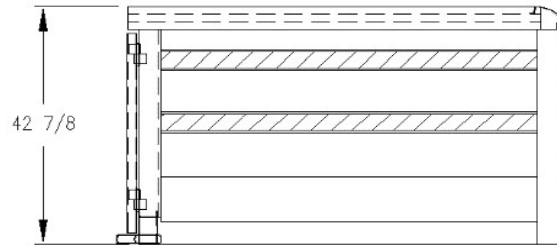
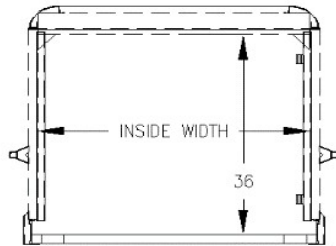
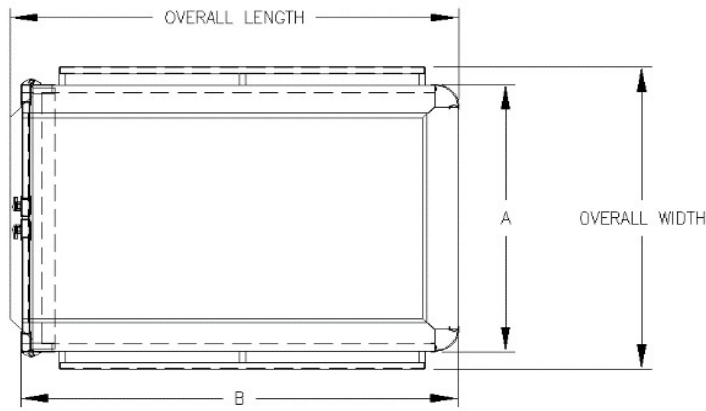

BOX WIDTH	BOX LENGTH	DIM A	DIM B	OVERALL WIDTH	OVERALL LENGTH	INSIDE WIDTH
44"	60"	44"	60"	50-1/4"	61-7/8"	41"
48"	72"	48"	72"	54-1/4"	73-7/8"	45"

TITLE

STOCK BOX DIMENSIONS

DWG NO.	REV	DATE	DRAWN BY	SCALE	PAGE
	A	10-14-19	APD	1/20	

Hillsboro Industries
 220 Industrial Road
 Hillsboro, KS 67063

1-800-835-0209
 hi@hillsboroindustries.com
 www.hillsboroindustries.com