

STANDARD EQUIPMENT

10 YEAR LIMITED WARRANTY

Gooseneck w/ Tapered Nose, Padlock Securable Gates, 37" Wide Escape Door, Double Wall Sliding Center Gate w/ Slam Latch (2 Gates in 26' & Longer), Double Wall Sliding Rear Gate w/Posi-Latch, Rubber Rollers on Sliding Gates, Double Wall Smooth Extruded Sidewall, GN Compartment Fold Down Gate, 52" High Solid Sides on 6'8" Tall / 60" on 7'4" Tall, Adjustable GN Hitch Height, Full Length Running Boards (on 7' & 7'5" Trailers Only), 2-5/16 Coupler, Rear Skid Plate, Rear Rubber Bumper, Spare Tire Rack, Spare Tire & Wheel for Standard Axle, Single 10K Spring Loaded Drop Leg Jack, Flat Floor w/ Traction Surface, 62" Truck Clearance, Graphics Package, Conspicuity Tape, Wrap Around Latch Rear Gate, Heavy Duty Wiring Harness, Enclosed Brake Wiring, Safety Chains, One Piece Roof, Quick Change Pigtail, 7-Way Plug, High Mount LED Stop, Turn, & Tail Lights, Breakaway Battery w/ Charger & LED Dome Light (Switch on Light) in Front Compartment, LED Lights, Front ID Lights, Rubber Torsion Axles w/ Spindle Lube 8-Bolt Hubs, ST235/80R16 LR E Tires, 7K Axles w/ 12" x 2" Electric Brakes



6'8" TALL

ITEM	Column1	Column2	AXLE	WEIGHT(LBS)	GVWR	REF#	LIST PRICE
95036	ES7-16-68 GN Endura Stock F/G		2-7K	3735	14500	EN112NE98	\$ 27,530
95038	ES7-18-68 GN Endura Stock F/G		2-7K	3860	14500	EN912NE83	\$ 28,549
95040	ES7-20-68 GN Endura Stock F/G		2-7K	3985	14500	EN422NE18	\$ 29,114
95042	ES7-22-68 GN Endura Stock F/G		2-7K	4110	14500	EN822NE56	\$ 29,683
95044	ES7-24-68 GN Endura Stock F/G		2-7K	4235	14500	EN042NE79	\$ 31,271
95046	ES7-26-68 GN Endura Stock F/G		2-7K	4540	14500	EN752NE45	\$ 33,435
95048	ES7-28-68 GN Endura Stock F/G		2-7K	4665	14500	EN562NE99	\$ 34,544
95050	ES7-30-68 GN Endura Stock F/G		3-7K	5290	22610	EN303NE89	\$ 39,466
95052	ES7-32-68 GN Endura Stock F/G		3-7K	5415	22610	EN013NE34	\$ 40,304
95054	ES7-34-68 GN Endura Stock F/G		3-7K	5540	22610	EN613NE66	\$ 41,125

7'4" TALL

ITEM	Column1	Column2	AXLE	WEIGHT(LBS)	GVWR	REF#	LIST PRICE
95055	ES7-16-74 GN Endura Stock [OBS]		2-7K	3835	14500	EN212NE77	\$ 27,632
95057	ES7-18-74 GN Endura Stock F/G		2-7K	3970	14500	EN132NE46	\$ 30,060
95059	ES7-20-74 GN Endura Stock F/G		2-7K	4100	14500	EN532NE82	\$ 30,626
95061	ES7-22-74 GN Endura Stock F/G		2-7K	4235	14500	EN142NE85	\$ 31,409
95063	ES7-24-74 GN Endura Stock F/G		2-7K	4365	14500	EN942NE71	\$ 32,430
95065	ES7-26-74 GN Endura Stock F/G		2-7K	4680	14500	EN762NE43	\$ 34,731
95067	ES7-28-74 GN Endura Stock F/G		2-7K	4815	14500	EN572NE30	\$ 35,753
95069	ES7-30-74 GN Endura Stock F/G		3-7K	5445	22610	EN513NE65	\$ 40,994
95071	ES7-32-74 GN Endura Stock F/G		3-7K	5580	22610	EN723NE16	\$ 42,488
95073	ES7-34-74 GN Endura Stock [OBS]		3-7K	5710	22610	EN223NE09	\$ 41,830

STANDARD EQUIPMENT

10 YEAR LIMITED WARRANTY

Gooseneck w/ Tapered Nose, Padlock Securable Gates, 37" Wide Escape Door, Double Wall Sliding Center Gate w/ Slam Latch (2 Gates in 26' & Longer), Double Wall Sliding Rear Gate w/Posi-Latch, Rubber Rollers on Sliding Gates, Double Wall Smooth Extruded Sidewall, GN Compartment Fold Down Gate, 52" High Solid Sides on 6'8" Tall / 60" on 7'4" Tall, Adjustable GN Hitch Height, Full Length Running Boards (on 7' & 7'5" Trailers Only), 2-5/16 Coupler, Rear Skid Plate, Rear Rubber Bumper, Spare Tire Rack, Spare Tire & Wheel for Standard Axle, Single 10K Spring Loaded Drop Leg Jack, Flat Floor w/ Traction Surface, 62" Truck Clearance, Graphics Package, Conspicuity Tape, Wrap Around Latch Rear Gate, Heavy Duty Wiring Harness, Enclosed Brake Wiring, Safety Chains, One Piece Roof, Quick Change Pigtail, 7-Way Plug, High Mount LED Stop, Turn, & Tail Lights, Breakaway Battery w/ Charger & LED Dome Light (Switch on Light) in Front Compartment, LED Lights, Front ID Lights, Rubber Torsion Axles w/ Spindle Lube 8-Bolt Hubs, ST235/80R16 LR E Tires, 7K Axles w/ 12" x 2" Electric Brakes



6'8" TALL

ITEM	Column1	Column2	AXLE	WEIGHT(LBS)	GVWR	REF#	LIST PRICE
95300	ES7.5-16-68 GN Endura Stock F/G		2-7K	3860	14500	EN712NE88	\$ 28,296
95301	ES7.5-18-68 GN Endura Stock F/G		2-7K	3990	14500	EN622NE49	\$ 29,414
95302	ES7.5-20-68 GN Endura Stock F/G		2-7K	4120	14500	EN132NE58	\$ 30,075
95303	ES7.5-22-68 GN Endura Stock F/G		2-7K	4250	14500	EN632NE71	\$ 30,742
95304	ES7.5-24-68 GN Endura Stock F/G		2-7K	4380	14500	EN942NE68	\$ 32,426
95305	ES7.5-26-68 GN Endura Stock F/G		2-7K	4700	14500	EN762NE07	\$ 34,684
95306	ES7.5-28-68 GN Endura Stock F/G		3-7K	5330	22610	EN303NE03	\$ 39,355
95307	ES7.5-30-68 GN Endura Stock F/G		3-7K	5460	22610	EN413NE95	\$ 40,903
95308	ES7.5-32-68 GN Endura Stock F/G		3-7K	5590	22610	EN223NE14	\$ 41,836
95309	ES7.5-34-68 GN Endura Stock F/G		3-7K	5720	22610	EN923NE18	\$ 42,751

7'4" TALL

ITEM	Column1	Column2	AXLE	WEIGHT(LBS)	GVWR	REF#	LIST PRICE
95320	ES7.5-16-74 GN Endura Stock F/G		2-7K	3960	14500	EN922NE30	\$ 29,779
95321	ES7.5-18-74 GN Endura Stock F/G		2-7K	4100	14500	EN832NE09	\$ 30,921
95322	ES7.5-20-74 GN Endura Stock F/G		2-7K	4235	14500	EN342NE20	\$ 31,584
95323	ES7.5-22-74 GN Endura Stock F/G		2-7K	4375	14500	EN052NE00	\$ 32,468
95324	ES7.5-24-74 GN Endura Stock F/G		2-7K	4510	14500	EN852NE58	\$ 33,582
95325	ES7.5-26-74 GN Endura Stock F/G		2-7K	4840	14500	EN772NE03	\$ 35,978
95326	ES7.5-28-74 GN Endura Stock F/G		3-7K	5480	22610	EN213NE32	\$ 40,561
95327	ES7.5-30-74 GN Endura Stock F/G		3-7K	5615	22610	EN623NE72	\$ 42,431
95328	ES7.5-32-74 GN Endura Stock F/G		3-7K	5755	22610	EN833NE97	\$ 44,022
95329	ES7.5-34-74 GN Endura Stock F/G		3-7K	5890	22610	EN053NE75	\$ 45,552

STANDARD EQUIPMENT

10 YEAR LIMITED WARRANTY

Gooseneck w/ Tapered Nose, Padlock Securable Gates, 37" Wide Escape Door, Double Wall Sliding Center Gate w/ Slam Latch (2 Gates in 26' & Longer), Double Wall Sliding Rear Gate w/Posi-Latch, Rubber Rollers on Sliding Gates, Double Wall Smooth Extruded Sidewall, GN Compartment Fold Down Gate, 52" High Solid Sides on 6'8" Tall / 60" on 7'4" Tall, Adjustable GN Hitch Height, Rear Rubber Bumper, Spare Tire Rack, Spare Tire & Wheel for Standard Axle, Single 10K Spring Loaded Drop Leg Jack, Flat Floor w/ Traction Surface, 62" Truck Clearance, Graphics Package, Conspicuity Tape, Wrap Around Latch Rear Gate, Heavy Duty Wiring Harness, Enclosed Brake Wiring, Safety Chains, One Piece Roof, Quick Change Pigtail, 7-Way Plug, High Mount LED Stop, Turn, & Tail Lights, Breakaway Battery w/ Charger & LED Dome Light (Switch on Light) in Front Compartment, LED Lights, Front ID Lights, Rubber Torsion Axles w/ Spindle Lube 8-Bolt Hubs, ST235/80R16 LR E Tires, 7K Axles w/ 12" x 2" Electric Brakes, 2-5/16 Coupler, Rear Skid Plate



6'8" TALL

ITEM	Column1	Column2	AXLE	WEIGHT(LBS)	GVWR	REF#	LIST PRICE
95078	ES8-20-68 GN Endura Stock F/G		2-7K	4440	14500	EN042NE10	\$ 31,182
95080	ES8-22-68 GN Endura Stock F/G		2-7K	4575	14500	EN642NE03	\$ 31,952
95082	ES8-24-68 GN Endura Stock F/G		2-7K	4710	14500	EN852NE54	\$ 33,577
95084	ES8-26-68 GN Endura Stock F/G		3-7K	5545	22610	EN303NE37	\$ 39,399
95086	ES8-28-68 GN Endura Stock F/G		3-7K	5680	22610	EN313NE37	\$ 40,697
95088	ES8-30-68 GN Endura Stock F/G		3-7K	5815	22610	EN623NE03	\$ 42,342
95090	ES8-32-68 GN Endura Stock F/G		3-7K	5950	22610	EN333NE98	\$ 43,374
95092	ES8-34-68 GN Endura Stock F/G		3-7K	6085	22610	EN143NE74	\$ 44,382

7'4" TALL

ITEM	Column1	Column2	AXLE	WEIGHT(LBS)	GVWR	REF#	LIST PRICE
95097	ES8-20-74 GN Endura Stock F/G		2-7K	4555	14500	EN052NE59	\$ 32,544
95099	ES8-22-74 GN Endura Stock F/G		2-7K	4700	14500	EN852NE12	\$ 33,522
95101	ES8-24-74 GN Endura Stock F/G		2-7K	4840	14500	EN762NE43	\$ 34,731
95103	ES8-26-74 GN Endura Stock F/G		3-7K	5685	22610	EN313NE32	\$ 40,691
95105	ES8-28-74 GN Endura Stock F/G		3-7K	5830	22610	EN223NE67	\$ 41,905
95107	ES8-30-74 GN Endura Stock F/G		3-7K	5970	22610	EN733NE81	\$ 43,871
95109	ES8-32-74 GN Endura Stock F/G		3-7K	6115	22610	EN053NE79	\$ 45,557
95111	ES8-34-74 GN Endura Stock F/G		3-7K	6255	22610	EN363NE30	\$ 47,182

STANDARD EQUIPMENT

10 YEAR LIMITED WARRANTY
 2' V Nose (In Addition to Floor Length), Padlock Securable Gates, 37" Wide Escape Door, Double Wall Sliding Center Gate w/ Slam Latch, 7' Inside Width, 2,000# Sidewind Jack, Double Wall Sliding Rear Gate w/ Posi-Latch, Rubber Rollers on Sliding Gates, Double Wall Smooth Extruded Sidewall, Full Length Running Boards, 52" High Solid Sides on 6'8" Tall / 60" on 7'4" Tall, Flat Floor w/ Traction Surface, Rear Rubber Bumper, Spare Tire Rack, Spare Tire & Wheel for Standard Axle, Graphics Package, Conspicuity Tape, Wrap Around Latch Rear Gate, Heavy Duty Wiring Harness, Enclosed Brake Wiring, Safety Chains, One Piece Roof, Quick Change Pigtail, 7-Way Plug, High Mount LED Stop, Turn, & Tail Lights, Breakaway Battery w/ Charger, LED Dome Light (Switch on Light) in Front Compartment, LED Lights, Rubber Torsion Axles w/ Spindle Lube 8-Bolt Hubs, ST235/80R16 LR E Tires, 7K Axles w/ 12" x 2" Electric Brakes, 2-5/16 Coupler, Rear Skid Plate



6'8" TALL

ITEM	Column1	Column2	AXLE	WEIGHT(LBS)	GVWR	REF#	LIST PRICE
95359	ES7-14-68 BH Endura Stock F/G		2-7K	3085	14500	EN771NE06	\$ 22,995
95360	ES7-16-68 BH Endura Stock F/G		2-7K	3210	14500	EN381NE86	\$ 23,878
95361	ES7-18-68 BH Endura Stock F/G		2-7K	3395	14500	EN091NE65	\$ 24,760

7'4" TALL

ITEM	Column1	Column2	AXLE	WEIGHT(LBS)	GVWR	REF#	LIST PRICE
95363	ES7-14-74 BH Endura Stock F/G		2-7K	3175	14500	EN281NE76	\$ 23,735
95364	ES7-16-74 BH Endura Stock F/G		2-7K	3310	14500	EN091NE35	\$ 24,721
95365	ES7-18-74 BH Endura Stock F/G		2-7K	3445	14500	EN791NE93	\$ 25,705

ENDURA STOCK AXLE/BRAKE/TIRE OPTIONS

OPTIONS FOR (2) 7K RUBBER TORSION AXLES W/ST235/85R16E TIRES

ITEM			REF#	LIST PRICE
X9135	7K AXLE (2) RUBBER TORSION, 8-BOLT HUB	235/75R17.5 LRJ, 14500 GVWR	AL520SO98	\$ 3,374
X9062	7K AXLE (3), RUBBER TORSION ILOS (2)7K	ST235/80R16 LRE, 22610 GVWR	AL620SO83	\$ 3,484
X9064	7.2K AXLE (2), RUBBER TORSION ILOS (2)7K	ST235/80R16 LRE, 15000 GVWR	AL110SO54	\$ 1,499
X9063	8K AXLE (2), RUBBER TORSION ILOS (2)7K	ST235/85R16 LRG, 17500 GVWR	AL920SO04	\$ 3,771
X9066	8K AXLE (2), RUBBER TORSION ILOS (2)7K	235/75R17.5 LRJ, 17500 GVWR	AL540SO85	\$ 5,955
X9065	10K AXLE (2), RUBBER TORSION ILOS (2)7K	235/75R17.5 LRJ, 22610 GVWR	AL160SO49	\$ 7,986

OPTIONS FOR (3) 7K RUBBER TORSION AXLES W/ST235/85R16 LRE TIRES

ITEM			REF#	LIST PRICE
X9136	7K AXLE (3) RUBBER TORSION	235/75R17.5 LRJ, 22610 GVWR	AL530SO79	
X9068	8K AXLES (2), RUBBER TORSION ILOS (3)7K	ST235/85R16 LRG, 17500 GVWR	AL300SO96	\$ 514
X9132	8K AXLES (2) ILOS (3)7K AXLES	235/75R17.5 LRJ, 17500 GVWR	AL020SO80	\$ 2,701
X9069	10K AXLES (2), RUBBER TORSION ILOS (3)7K	235/75R17.5 LRJ, 35900 GVWR	AL730SO12	\$ 4,821

BRAKES

ITEM			REF#	LIST PRICE
X9070	ELECTRIC/HYDRAULIC BRAKES, ILOS 2 ELECT		BR720BR02	\$ 3,509
X9071	ELECTRIC/HYDRAULIC BRAKES, ILOS 3 ELECT		BR030BR61	\$ 3,975

TIRE/WHEEL OPTIONS (ILOS)

ITEM			REF#	LIST PRICE
X9072	T/W ST235/85R 16 LR G ILOS 16E	Westlake	AL100SO59	\$ 206
X9074	T/W 235/75R 17.5 LR J ILOS 16E	Westlake	AL200SO68	\$ 348

TIRE/WHEEL OPTIONS (ADDITIONAL SPARE)

ITEM			REF#	LIST PRICE
234294	TIRE & WHEEL ST235/80R16E W/SL MOD LION	Castle Rock	TI100WH92	\$ 249
234296	TIRE & WHEEL ST235/85R16G W/SL MOD LION	Westlake	TI300WH22	\$ 418
234398	TIRE & WHEEL 235/75R17.5J W/SL MOD LION	Westlake	TI400WH54	\$ 590
X9076	ALUMINUM SPOKE T/W ILOS 16" WHEEL	*price per wheel	AL100SO97	\$ 256
X9075	ALUM WHEEL ILOS 17.5 J WHEEL	*price per wheel	AL100SO97	\$ 256

ENDURA STOCK ACCESSORIES AND OPTIONS

BODY & FRAME OPTIONS

ITEM			REF#	LIST PRICE
X9003	3" SLOTTED SIDES (28" FROM FLOOR)	<i>per Trailer</i>	AL200SO09	\$ 271
X9001	FRONT VENT & COVER		AL300SO26	\$ 423
X9004	TIE RAIL (INSIDE OR OUTSIDE)	<i>per ft.</i>	AL000SO24	\$ 31
231744	TIE LOOP CAST AL	<i>Bolt-On, External (price each)</i>	MI000 P08	\$ 10
89321	TIE LOOP, 1/2" AL ROUND X 7-1/2"	<i>Weld-On, Internal (price each)</i>	AL000 P07	\$ 9
X9007	DUAL JACK, SINGLE SPEED ILOS	<i>Gooseneck Only</i>	AL300SO08	\$ 400
X9008	DUAL JACK, 2 SPD GEARBOX ILOS	<i>Gooseneck Only</i>	AL600SO37	\$ 827
X9009	12K ELECT/HYD BIG FOOT JACK ILOS	<i>Gooseneck Only, Includes Battery</i>	AL520SO07	\$ 3,256

ESCAPE DOOR & SIDE RAMP OPTIONS (14,500 GVWR)-Restrictions may apply to placement

ITEM			REF#	LIST PRICE
X9016	ADDITIONAL 37" ESCAPE DOOR, EITHER SIDE		AL700SO25	\$ 942
X9127	52" WIDE ESCAPE DOOR, ADDITIONAL		AL900SO65	\$ 1,253
X9013	52" WIDE ESCAPE DOOR ILOS		AL200SO47	\$ 321
X9128	52" WIDE ESCAPE DOOR, NO SILL, ILOS 37"		AL010SO58	\$ 1,374
X9129	52" WIDE ESCAPE DOOR, NO SILL, ADD		AL710SO78	\$ 2,309
X9015	52" WIDE FOLD DOWN SIDE RAMP		AL020SO93	\$ 2,718
X9014	52" WIDE FOLD DOWN SIDE RAMP ILOS		AL310SO76	\$ 1,787
X9130	52"W FOLD DOWN SIDE RAMP, NO SILL, ADD		AL920SO04	\$ 3,771
X9131	52"W FOLD DOWN SIDE RAMP, NO SILL, ILOS		AL120SO88	\$ 2,842
X9017	FULLY ENCLSD LIVESTOCK ESCAPE DOOR ILOS		AL100SO44	\$ 187

**LIMITED TO 14,500 GVWR when used in Addition to 37" or 52" Wide Escape Door

Larger than 14,500 GVWR or 2-7K axles-call sales for additional frame structure pricing

CENTER GATE OPTIONS

ITEM			REF#	LIST PRICE
X9020	DELETE SLIDING CENTER GATE & POSTS		AL00-SO40	\$ (540)
X9021	MOVE CENTER GATE FROM STANDARD POSITION		AL100SO96	\$ 255
X9022	ADJ SOLID CNTR GATE ILOS, NO SLIDER		AL210SO54	\$ 1,629
X9023	ADJ SOLID CNTR GATE, NO SLIDER		AL520SO04	\$ 3,252
X9134	ADJ SLIDING CNTR GATE ILOS		AL410SO75	\$ 1,916
x9133	ADJ SLIDIING CNTR GATE		AL720SO24	\$ 3,538
X9002	ADD SLIDING CENTER GATE		AL210SO51	\$ 1,625
X9024	SOLID CENTER GATE ILOS		AL000SO00	\$ -
X9025	ADDITIONAL SOLID CENTER GATE		AL010SO64	\$ 1,382
X9026	ADDITIONAL SET OF CENTER GATE POSTS		AL400SO26	\$ 553
X9027	3" SLOT IN CENTER GATE		AL000SO81	\$ 105
X9140	PEN (1 PAIR, 4' LONG)		AL310SO15	\$ 1,708

REAR GATE OPTIONS (ILOS)

ITEM			REF#	LIST PRICE
X9028	SOLID REAR GATE (NON-SLIDING)	<i>w/ Standard L.S. Opening</i>	AL000SO00	\$ -
X9029	ENCLOSED SOLID (NON-SLIDING) REAR GATE		AL000SO00	\$ -
X9030	1/2 ROLL-UP DOOR IN LIVESTOCK REAR GATE		AL600SO77	\$ 879
X9031	3" SLOT IN REAR GATE		AL000SO81	\$ 105
X9032	DOUBLE REAR DOORS WITH CAM LATCH		AL200SO42	\$ 314
X9033	DBL REAR DOORS W/ FOLD AROUND HINGES	<i>Lay Flat Hinges</i>	AL600SO26	\$ 813
X9137	4' REAR RAMP BEHIND REAR GATE		AL420SO40	\$ 3,169

GN COMPARTMENT GATES & DOORS

ITEM			REF#	LIST PRICE
X9010	GN SLAM DOOR W/ LOCK	Available on Both Sides	AL400SO03	\$ 523
X9011	WINDOW IN GOOSENECK COMPARTMENT 15X34	Available on Both Sides	AL200SO38	\$ 309
X9012	GN SLAM DOOR WITH LOCK ON FRONT OF NOSE	Drop Down	AL600SO26	\$ 813
X9018	EZ STORE RAMPS ILOS FOLD DOWN GN GATE		AL300SO06	\$ 397

DOUBLE DECK OPTIONS

ITEM			REF#	LIST PRICE
X9036	DOUBLE DECK RAIL, PER FT. OF TRAILER		AL000SO34	\$ 44
X9037	SPLIT SLIDING CENTER GATE ILOS		AL500SO42	\$ 704
X9038	SPLIT SLIDING REAR GATE ILOS		AL500SO42	\$ 704
X9039	SPLIT ESCAPE DOOR		AL100SO56	\$ 203
X9040	DOUBLE DECK FLOORING, 7' WIDTH, PER FT	weight rating 70lbs per sqft per ft	AL100SO17	\$ 152
X9041	DOUBLE DECK FLOORING, 8' WIDTH, PER FT	weight rating 70lbs per sqft per ft	AL100SO31	\$ 170

** weight rating 70lbs per sqft per ft

LIGHTING OPTIONS

ITEM			REF#	LIST PRICE
X9042	LED LOADING LIGHT - REQUIRES SWITCH	1900 Lumens	AL100SO49	\$ 194
X9043	RECESSED TOGGLE SWITCH - DOME OR LOAD		AL000SO50	\$ 65
X9045	EXTRA LED CLEARANCE LIGHTS (PER PAIR)		AL000SO58	\$ 75
X9046	RECESSED 3 WAY TOGGLE SWITCH	Requires 2	AL000SO62	\$ 81
X9047	LED BACK UP LIGHTS (PER PAIR)		AL300SO08	\$ 400
X9048	LED DOME LIGHT		AL000SO62	\$ 81

VENTS

ITEM			REF#	LIST PRICE
X9049	CRANK-UP ROOF VENT		AL100SO54	\$ 200
X9050	DRAFT/EXHAUST (POP-UP) ROOF VENT		AL100SO42	\$ 184

RUBBER MAT (Add rubber matting cost and installation cost)

ITEM			REF#	LIST PRICE
X9051	1/2"X60"X84" RUBBER MATTING	per Sheet	AL100SO51	\$ 196
X9052	3/4"X60"X84" RUBBER MATTING	per Sheet	AL100SO80	\$ 234
X9053	INSTALLATION OF MATTING FOR 7.0' TRAILER		AL100SO88	\$ 244
X9054	INSTALLATION OF MATTING FOR 7.5' AND 8.0		AL200SO99	\$ 388

PLEXI-GLASS & STORAGE

ITEM			REF#	LIST PRICE
91899	ENDURA PLEXIGLASS HARDWARE KIT		KI100KI23	\$ 160
233851	PLEXIGLASS STRIP 3/16 X 7-3/16 X 96 BRNZ	Sold in 8' Lengths	MI000 P55	\$ 71
X9035	PLEXI-GLASS INSTALLED AT HILLSBORO	per ft.	AL000SO65	\$ 84
X9034	PLEXI-GLASS STORAGE TRAY	GN or Straight Hitch Trailer	AL300SO94	\$ 512

** Plexi-Glass Install Kit Includes: 50 retention plugs, 14 filler end pieces, 1 drill guide, and installation instructions

*** Plexi-Glass Installed per foot of trailer, Includes 2 slots left side, 2 slots right side, escape door & rear gate

****Pricing = MSRP * Length(feet) of Trailer, Includes 2 slots left side, 2 slots right side, escape door & rear gate

COMBO ROOF COVE & GOOSENECK NOSE BLACK

ITEM			REF#	LIST PRICE
X9056	(1) PAINT ROOF COVE - BLACK	(Trailer + Nose Length) * MSRP = Price	AL000SO35	\$ 45
X9057	(2) PAINT GOOSENECK NOSE BLACK	Includes Nose and Sides	AL400SO90	\$ 636

** example (1)+(2) :7x20+8' nose = (28 ft total trailer x \$45= \$1260)+(\$636) = \$1896

PAINT ROOF COVE /ft of total trailer length (include gooseneck & 2' V-Nose)

ITEM			REF#	LIST PRICE
X9055	PAINT ROOF COVE - BLACK	(Trailer + Nose Length) * MSRP = Price	AL000SO35	\$ 45

** Example: SH 7x18 + 2' v-Nose = 20 ft total trailer X \$45 = \$900

ENDURA LIVESTOCK AND COMBO OPTIONS

BODY & FRAME OPTIONS

ITEM			REF#	LIST PRICE
X9077	FULLY ENCLOSE SIDE (PER FT)	<i>per ft./ per side</i>	AL000SO63	\$ 82

DRESSING ROOM OPTIONS (d/r)

ITEM			REF#	LIST PRICE
X9078	ANGLED D/R W/ SEALED DOOR, 2; SHORT WALL	<i>Deletes Escape Door</i>	AL610SO12	\$ 2,094
X9079	4' RECTANGULAR D/R W/ SEALED D/R DOOR	<i>Deletes Escape Door</i>	AL610SO12	\$ 2,094
X9080	SLIDE OUT CAMPER STEP - D/R DOOR	<i>N/A on 8' W Trailer</i>	AL200SO53	\$ 329
X9081	SADDLE RACK, 2 PEDESTAL		AL500SO00	\$ 649
X9082	SADDLE RACK, 3 PEDESTAL		AL600SO16	\$ 800
X9083	SADDLE RACK, 4 PEDESTAL		AL700SO36	\$ 956
X9084	TACK HOOKS, BAR OF 6		AL000SO71	\$ 92
X9085	BRUSH TRAY - SPECIFY PLACEMENT		AL000SO75	\$ 97
X9086	BLANKET BAR		AL000SO62	\$ 81
X9088	WALK THROUGH DOOR FROM D/R TO LIVESTOCK		AL600SO54	\$ 849

LIVESTOCK/HORSE COMPARTMENT OPTIONS

ITEM			REF#	LIST PRICE
X9089	SLANT STALL DIVIDER, PADDED		AL700SO72	\$ 1,003
X9090	SLANT STALL DIVIDER, PADDED, TELESCOPING		AL010SO71	\$ 1,391
X9091	FULL SLANT STALL DIVIDER/STUD GATE ILOS		AL010SO51	\$ 1,365
X9092	PADDING ON LIVESTOCK SIDE OF ANGLE WALL		AL000SO98	\$ 127
X9093	KICK PANEL - RUBBER 48" HEIGHT	<i>Head Side, per ft.</i>	AL000SO69	\$ 90
94263	BOLT-ON TIE LOOP PACKAGE	<i>External (price each)</i>	EN000NE37	\$ 48
89321	TIE LOOP, 1/2" AL ROUND X 7-1/2"	<i>Weld-On, Internal (price each)</i>	AL000 P07	\$ 9
X9004	TIE RAIL (INSIDE OR OUTSIDE)	<i>per ft.</i>	AL000SO24	\$ 31

WINDOWS

ITEM			REF#	LIST PRICE
X9011	WINDOW IN GOOSENECK COMPARTMENT 15X34	<i>Available on Both Sides</i>	AL200SO38	\$ 309
X9095	SIDE WINDOW 14X21		AL200SO05	\$ 266

ENDURA PLEX USAGE

ENDURA RUBBER MAT USAGE

2 Slot includes Escape Door & Rear Gate / 3 Slot includes slotted Escape Door & Slotted Rear Gate

# SLOTS	Length	# of 7-3/16 strip	# of 4-7/16	Length	7' W	7.5' W	8' W
2	16	9	-	16	3.2	3.5	3.8
2	18	10	-	18	3.6	4	4.3
2	20	11	-	20	4	4.5	4.8
2	22	12	-	22	4.4	5	5.3
2	24	13	-	24	4.8	5.5	5.8
2	26	14	-	26	5.2	6	6.3
2	28	15	-	28	5.6	6.5	6.8
2	30	16	-	30	6	7	7.3
2	32	17	-	32	6.4	7.5	7.8
2	34	18	-	34	6.8	8	8.3
3	9	5	5				
3	10	5.5	5.5				
3	11	6	6				
3	12	6.5	6.5				
3	13	7	7				
3	14	7.5	7.5				
3	15	8	8				
3	16	8.5	8.5				
3	17	9	9				
3	18	9.5	9.5				

ENDURA STANDARD GATE PLACEMENTS

*Note: To get exact compartment sizes, the thickness of the gates must be deducted. The thickness of a sliding center gate is approximately 4".

Goosenecks	Length	Gates	Compartment ments	Compartment sizes			Front Compartment with adjustable position from
				Front	Middle	Rear	
	16'	1	2	6' 11"	n/a	9' 1"	n/a
	18'	1	2	8' 5"	n/a	9' 7"	n/a
	20'	1	2	9' 5"	n/a	10' 7"	8'
	22'	1	2	10' 5"	n/a	11' 7"	8'
	24'	1	2	11' 11"	n/a	12' 1"	10'
	24'	2	3	8'	8'	8'	10'
	26'	2	3	8' 8"	8' 8"	8' 8"	10'
	28'	2	3	9' 4"	9' 4"	9' 4"	12'
	30'	2	3	10'	10'	10'	12'
	32'	2	3	10' 8"	10' 8"	10' 8"	12'
	34'	2	3	11' 4"	11' 4"	11' 4"	12'
Straigh Hitch	Length	Gates	Compartment ments	Compartment sizes			Front Compartment with adjustable position from
				Front	Middle	Rear	
	14'	1	2	7'	n/a	7'	n/a
	16'	1	2	8'	n/a	8'	n/a

ENDURA PAINT & POLISH OPTIONS

GREEN = PAINT

OPTION 1: PAINT ROOF COVE BLACK
INCLUDES SIDES AND FRONT

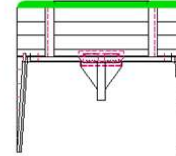

OPTION 2: PAINT NOSE BLACK
INCLUDES SIDES AND FRONT

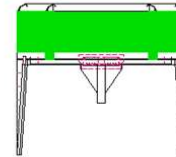
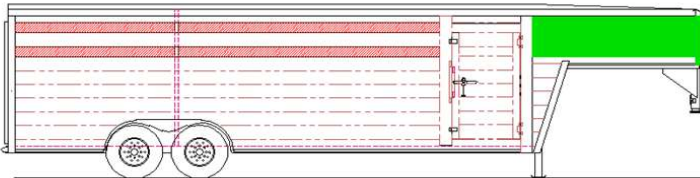

OPTION 3: PAINT ROOF COVE AND NOSE BLACK
COMBINE COST OF OPTION 1 AND OPTION 2 FOR DEALER COST

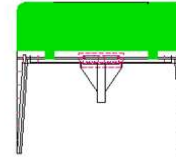

TITLE

PAINT OPTIONS

DWG NO.	REV	DATE	DRAWN BY	SCALE	PAGE
	A	12-7-16	APD	1/60	

*Hillsboro Industries
220 Industrial Road
Hillsboro, KS 67063*

*1-800-835-0209
hi@hillsboroindustries.com
www.hillsboroindustries.com*

ENDURA PAINT & POLISH OPTIONS

GREEN = PAINT

YELLOW = TREAD PLATE

OPTION 1: PAINT ROOF COVE BLACK

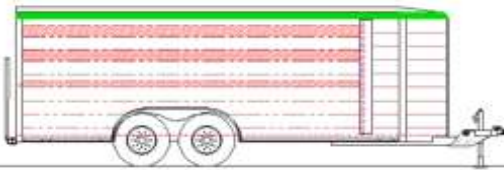

OPTION 7: PAINT ROOF COVE, AND CORNER COVE BLACK
SHOWN WITH OPTIONAL POLISHED V-NOSE AND ROCK GUARD

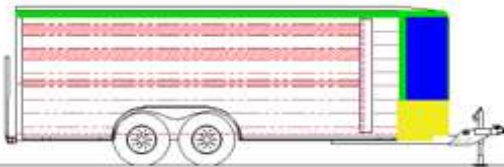

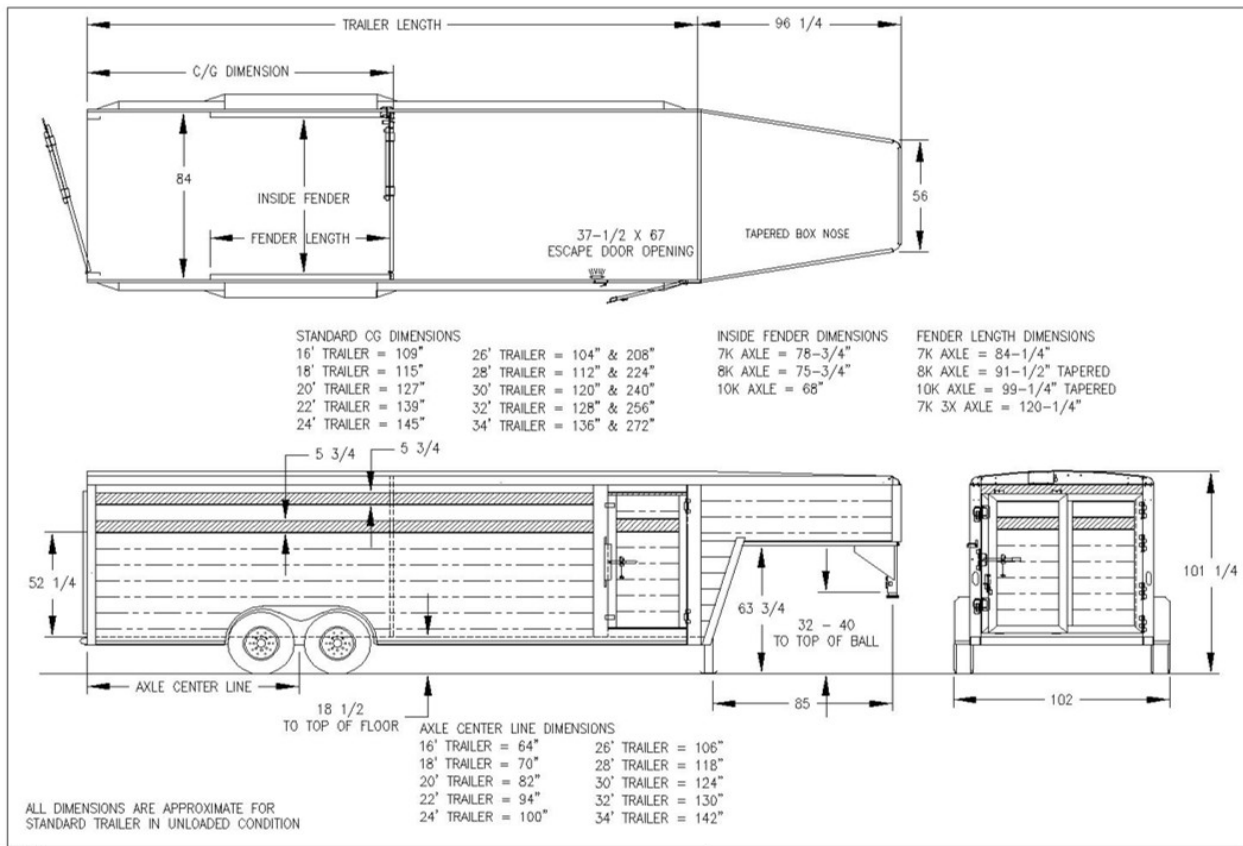

TITLE: 7' WIDE X 6'8" TALL ENDURA LIVESTOCK TRAILER

DWG NO.: ?????

REV: E

DATE: 9-15

DRAWN BY: APD

SCALE: 1/60

PAGE:

Hillsboro Industries
220 Industrial Road
Hillsboro, KS 67063

1-800-835-0209
hi@hillsboroindustries.com
www.hillsboroindustries.com

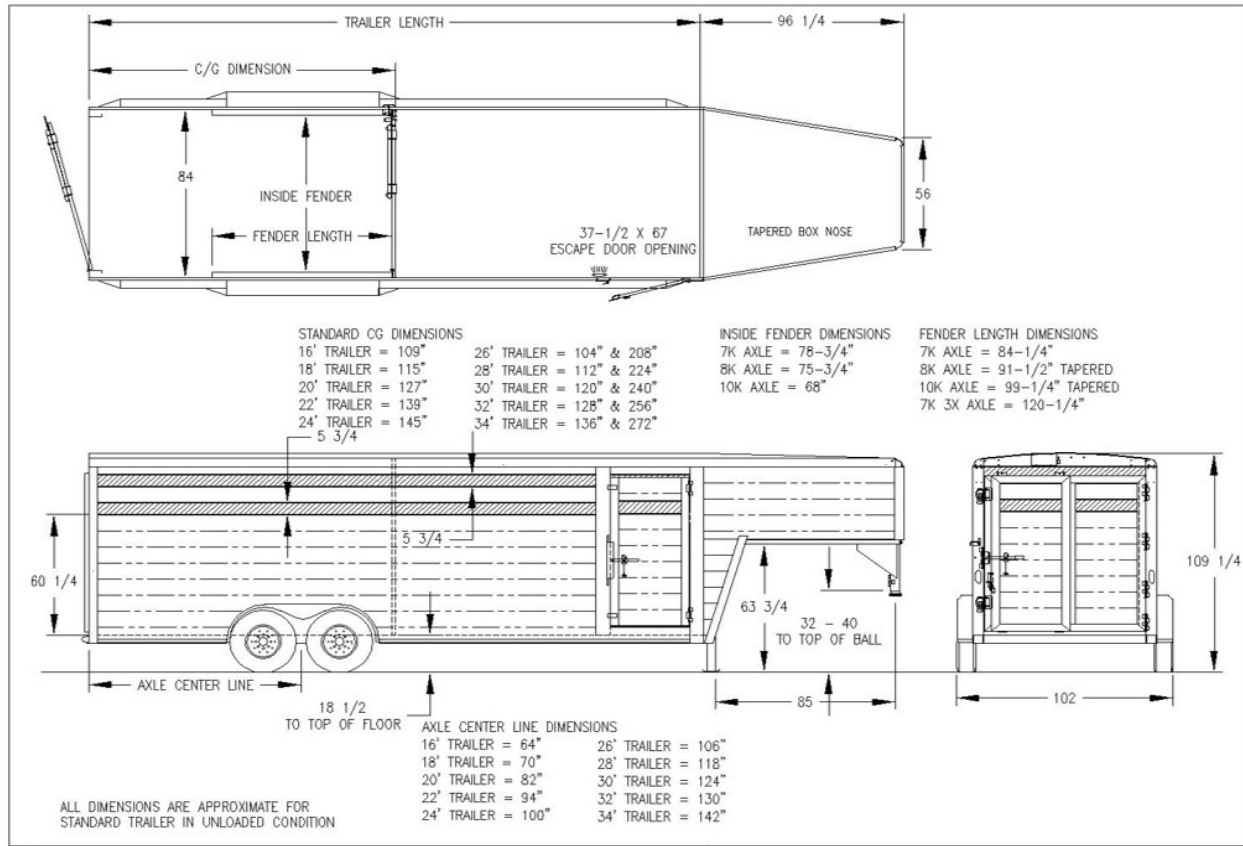

TITLE: 7' WIDE X 7'4" TALL ENDURA LIVESTOCK TRAILER

DWG NO.: ?????

REV: E

DATE: 9-15

DRAWN BY: APD

SCALE: 1/60

PAGE:

Hillsboro Industries
220 Industrial Road
Hillsboro, KS 67063

1-800-835-0209
hi@hillsboroindustries.com
www.hillsboroindustries.com

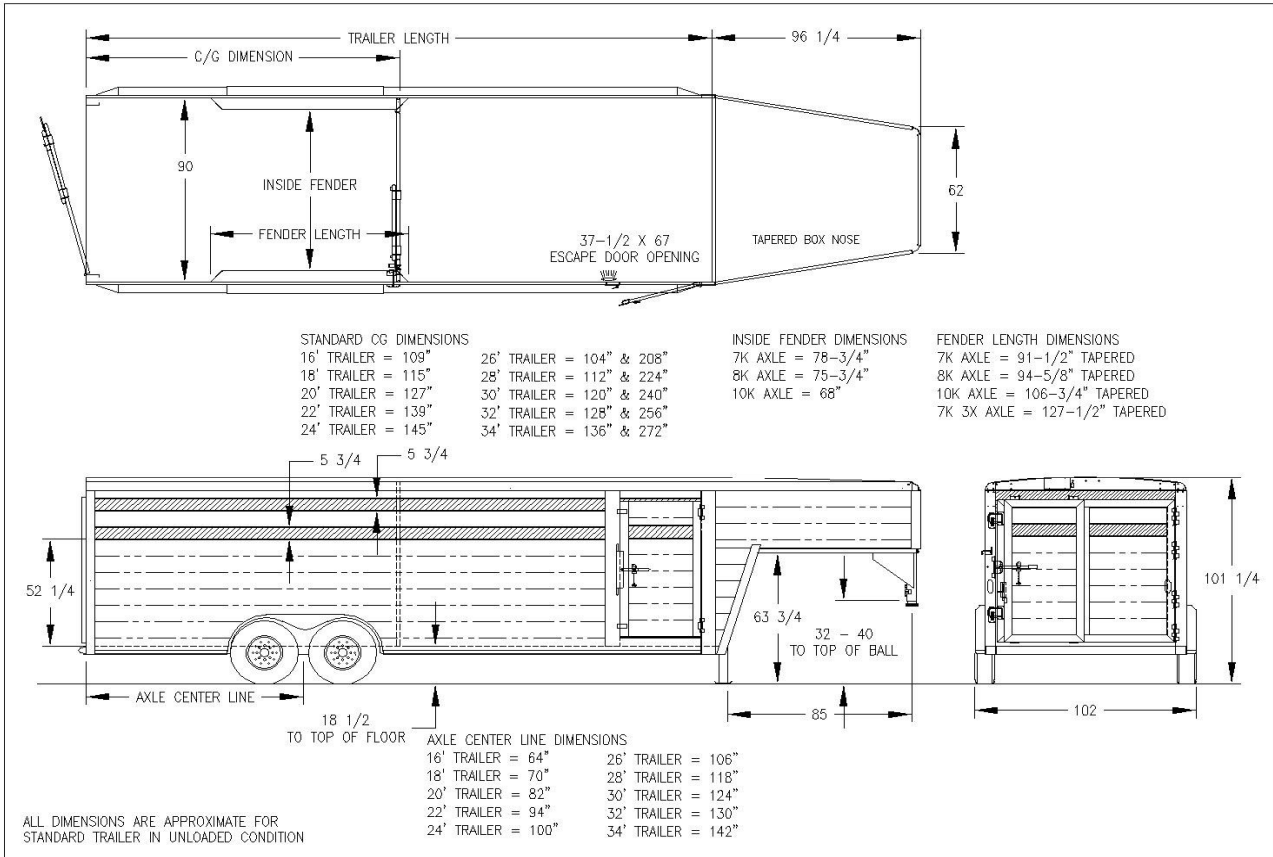

TITLE **7.5' WIDE X 6'8" TALL ENDURA LIVESTOCK TRAILER**

Hillsboro Industries
220 Industrial Road
Hillsboro, KS 67063

1-800-835-0209
hi@hillsboroindustries.com
www.hillsboroindustries.com

DWG NO. ?????	REV A	DATE 9-15	DRAWN BY APD	SCALE 1/60	PAGE
---------------	-------	-----------	--------------	------------	------

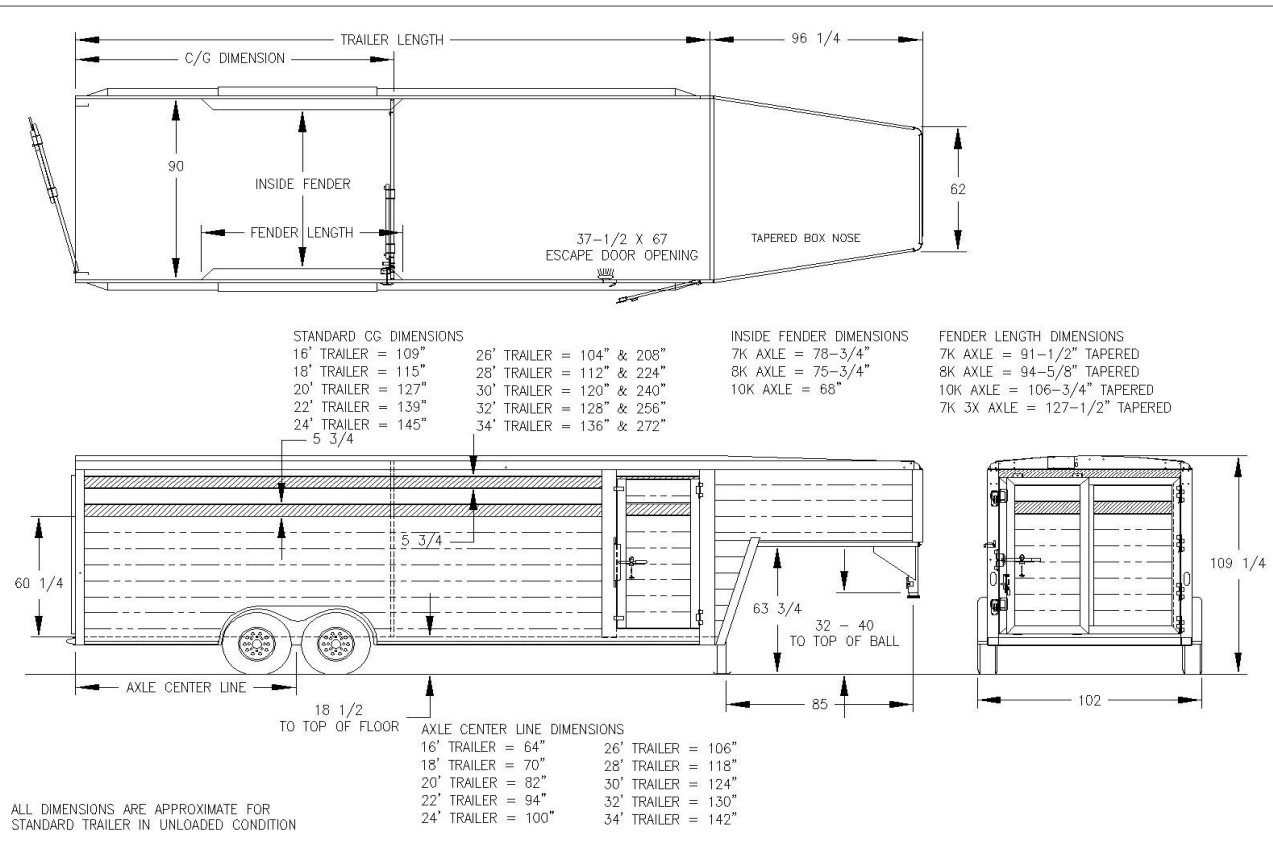

TITLE **7.5' WIDE X 7'4" TALL ENDURA LIVESTOCK TRAILER**

Hillsboro Industries
220 Industrial Road
Hillsboro, KS 67063

1-800-835-0209
hi@hillsboroindustries.com
www.hillsboroindustries.com

DWG NO. ?????	REV A	DATE 9-15	DRAWN BY APD	SCALE 1/60	PAGE
---------------	-------	-----------	--------------	------------	------

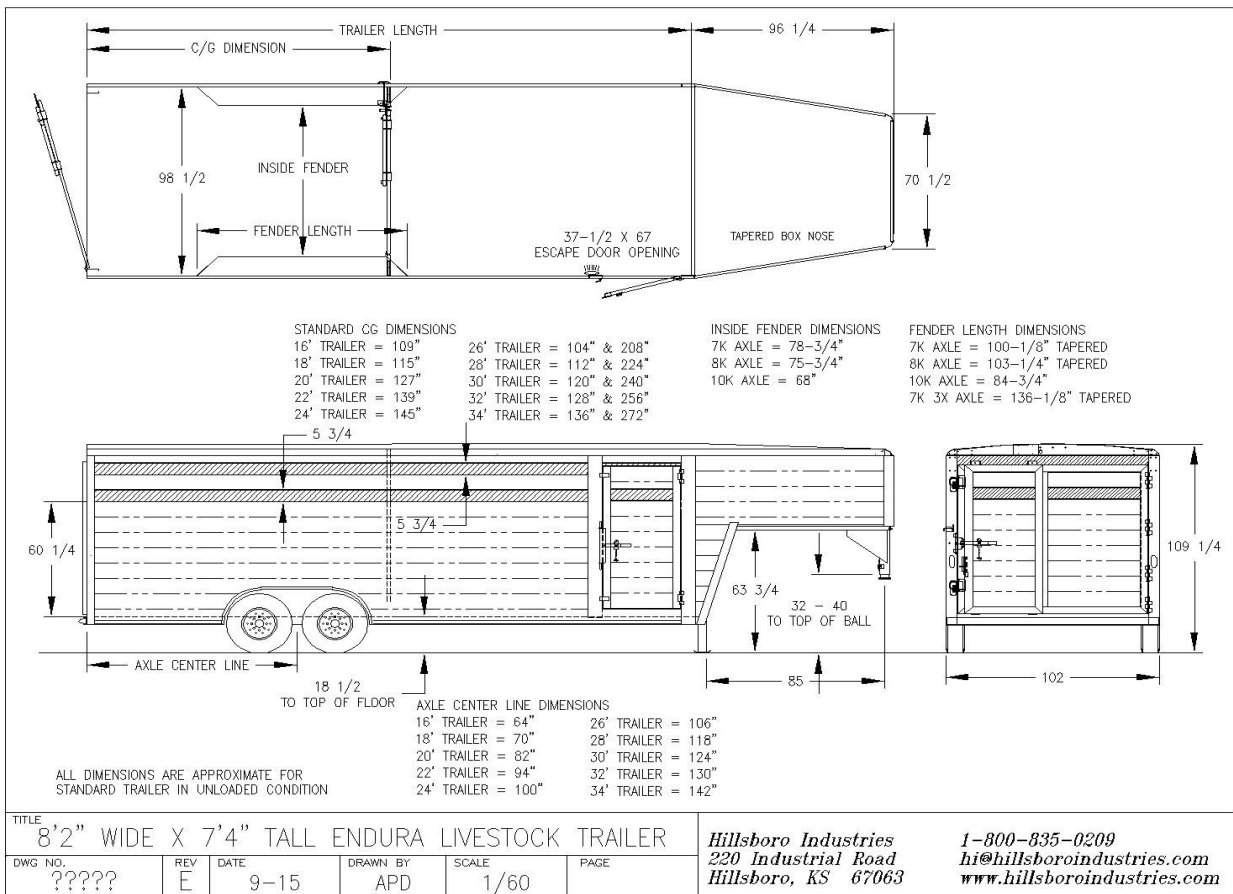
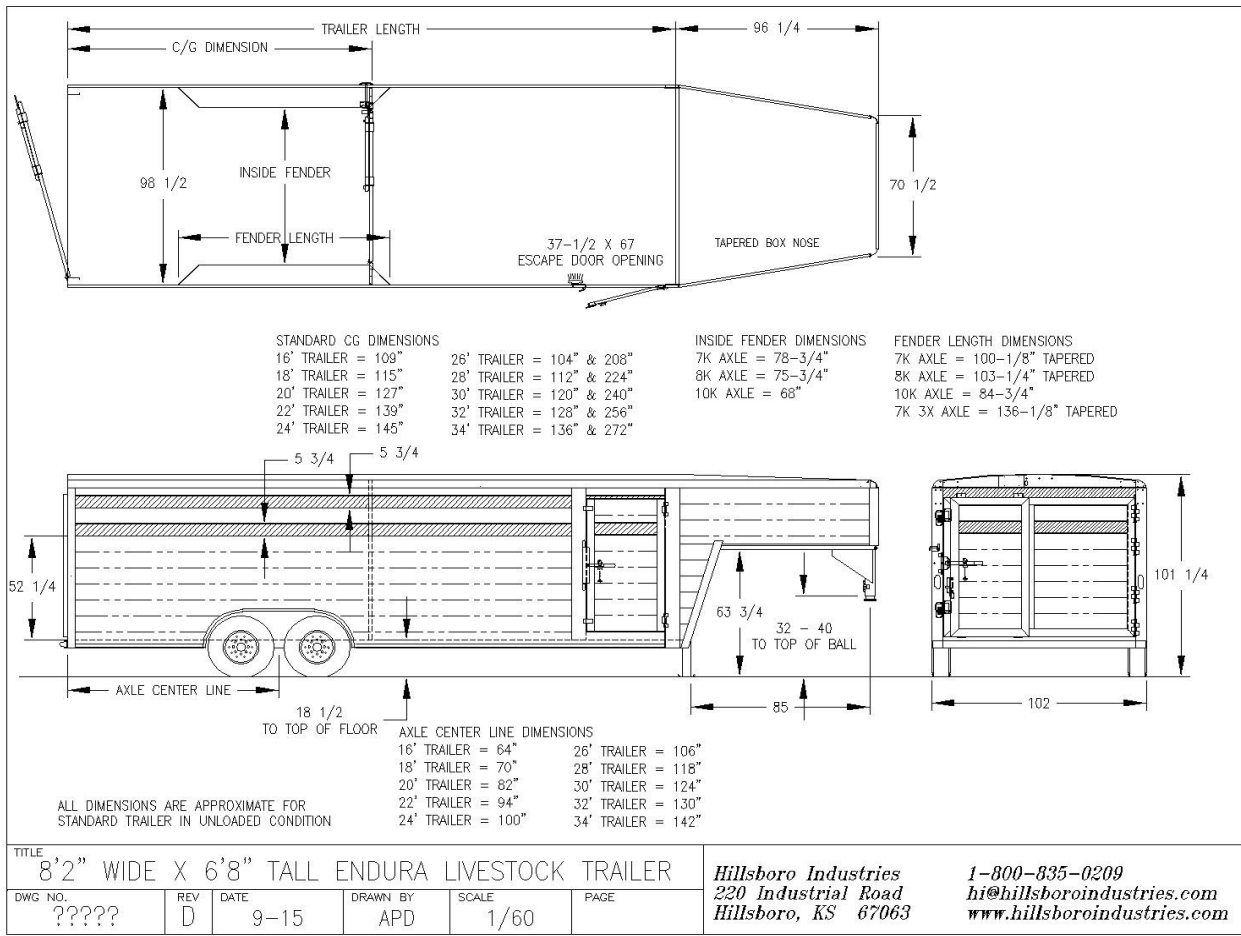

ENDURA STOCK TRAILERS 7W CENTER GATE PASS-THROUGH WIDTH

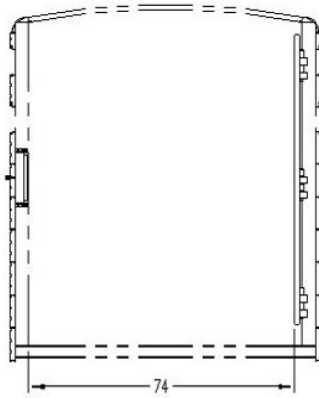

PASS-THROUGH WIDTH
W/ 6K, 7K OR 7.2K AXLES
SHOWN WITH CENTER GATE OPEN

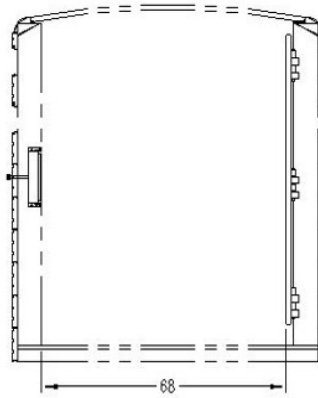

PASS-THROUGH WIDTH
W/ 8K AXLES
SHOWN WITH CENTER GATE OPEN

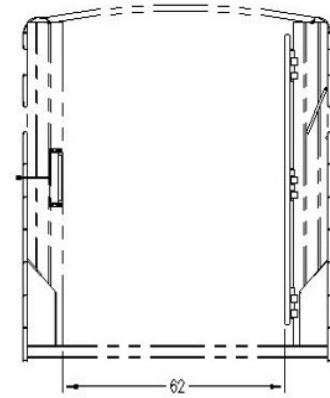

PASS-THROUGH WIDTH
W/ 10K AXLES
SHOWN WITH CENTER GATE OPEN

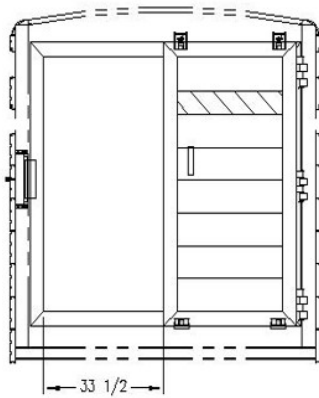

PASS-THROUGH WIDTH
W/ 6K, 7K OR 7.2K AXLES
SHOWN WITH ROLLER DOOR OPEN

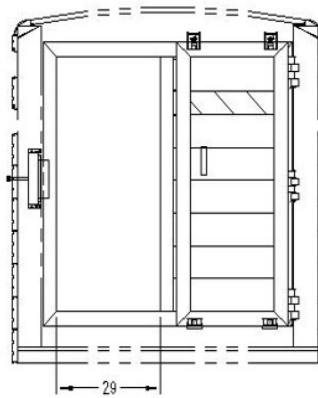

PASS-THROUGH WIDTH
W/ 8K AXLES
SHOWN WITH ROLLER DOOR OPEN

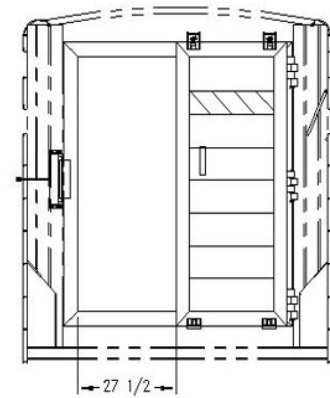

PASS-THROUGH WIDTH
W/ 10K AXLES
SHOWN WITH ROLLER DOOR OPEN

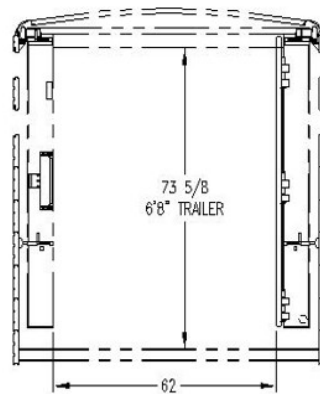

PASS-THROUGH DIMENSIONS
ADJUSTABLE POSITION CENTER GATE

ENDURA STOCK TRAILERS 7'6"W CENTER GATE PASS-THROUGH WIDTH

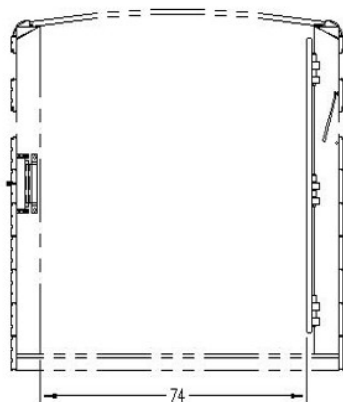

PASS-THROUGH WIDTH
W/ 6K, 7K OR 7.2K AXLES
SHOWN WITH CENTER GATE OPEN

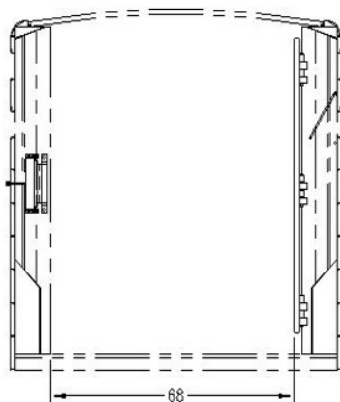

PASS-THROUGH WIDTH
W/ 8K AXLES
SHOWN WITH CENTER GATE OPEN

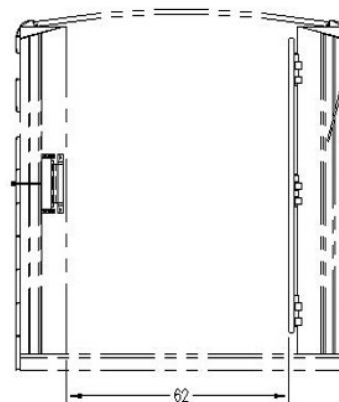

PASS-THROUGH WIDTH
W/ 10K AXLES
SHOWN WITH CENTER GATE OPEN

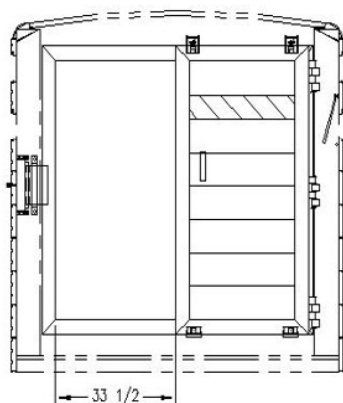

PASS-THROUGH WIDTH
W/ 6K, 7K OR 7.2K AXLES
SHOWN WITH ROLLER DOOR OPEN

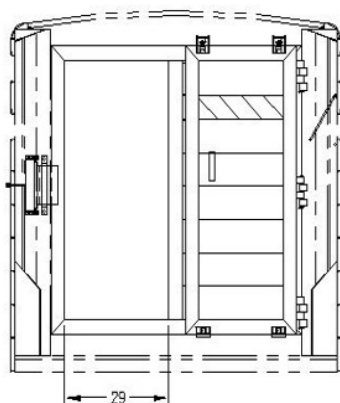

PASS-THROUGH WIDTH
W/ 8K AXLES
SHOWN WITH ROLLER DOOR OPEN

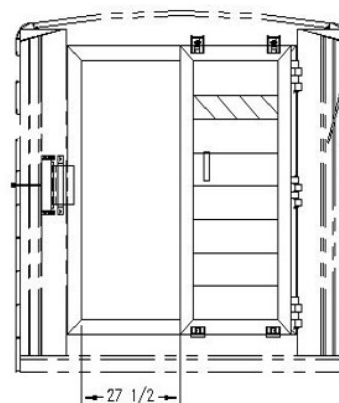

PASS-THROUGH WIDTH
W/ 10K AXLES
SHOWN WITH ROLLER DOOR OPEN

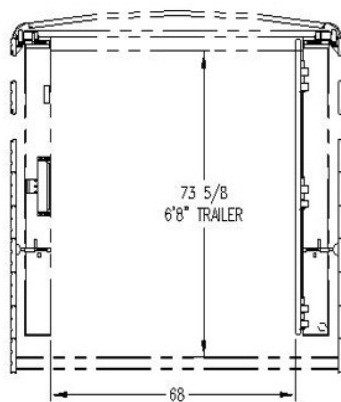

PASS-THROUGH DIMENSIONS
ADJUSTABLE POSITION CENTER GATE

ENDURA STOCK TRAILERS 8'2"W

CENTER GATE PASS-THROUGH WIDTH

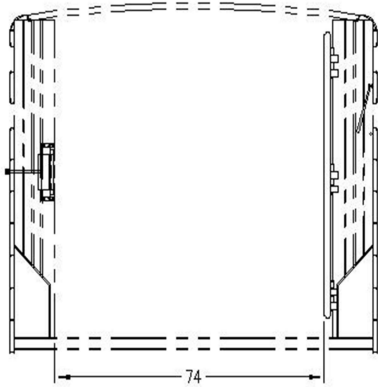

PASS-THROUGH WIDTH
W/ 6K, 7K OR 7.2K AXLES
SHOWN WITH CENTER GATE OPEN

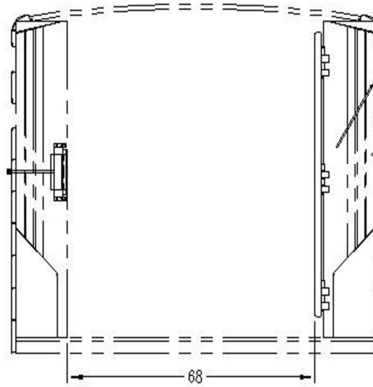

PASS-THROUGH WIDTH
W/ 8K AXLES
SHOWN WITH CENTER GATE OPEN

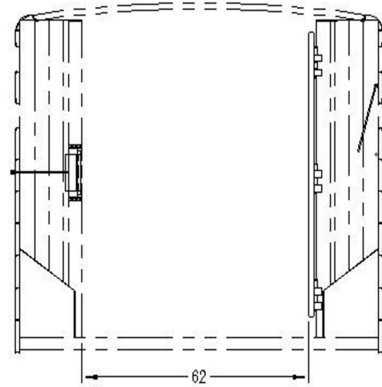

PASS-THROUGH WIDTH
W/ 10K AXLES
SHOWN WITH CENTER GATE OPEN

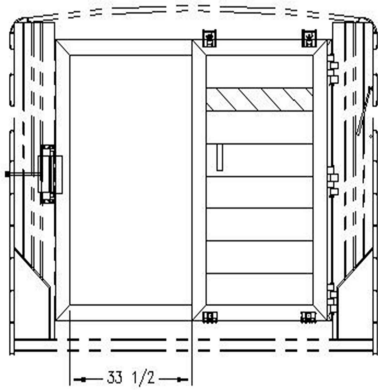

PASS-THROUGH WIDTH
W/ 6K, 7K OR 7.2K AXLES
SHOWN WITH CENTER GATE OPEN

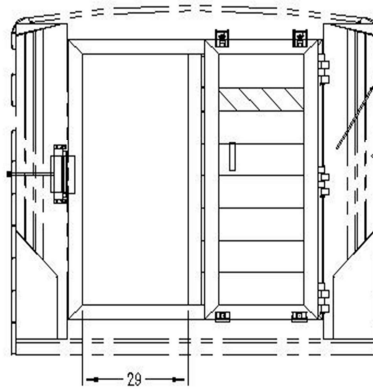

PASS-THROUGH WIDTH
W/ 8K AXLES
SHOWN WITH CENTER GATE OPEN

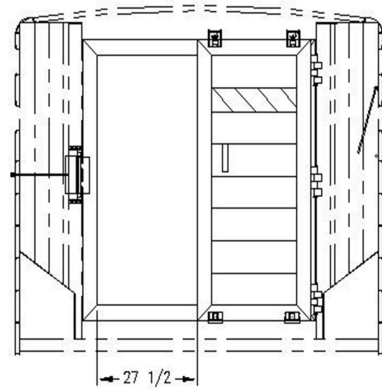

PASS-THROUGH WIDTH
W/ 10K AXLES
SHOWN WITH CENTER GATE OPEN

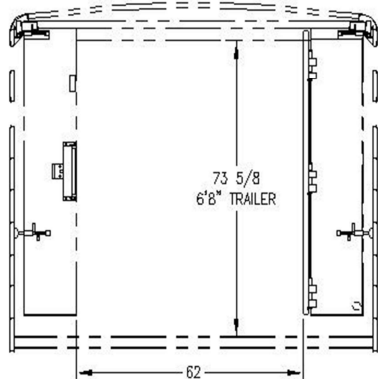

PASS-THROUGH DIMENSIONS
ADJUSTABLE POSITION CENTER GATE

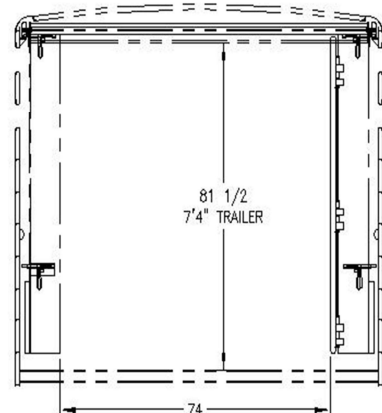

REAR GATE CONFIGURATIONS, ENDURA STOCK TRAILERS 7W 6'8" T

STANDARD CONFIGURATION

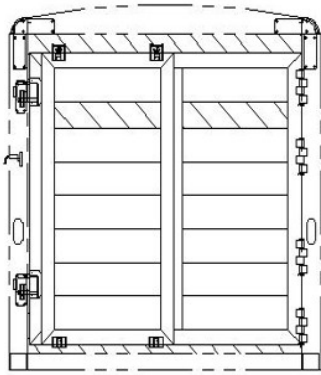

6'8" TALL, STANDARD LIVESTOCK SLIDER
REAR OPENING - 76W X 76T

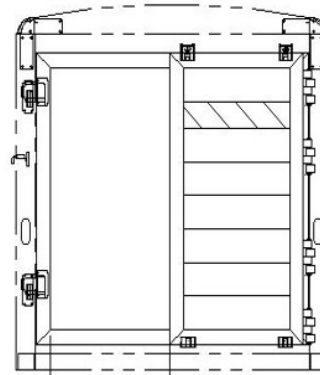

← 33 1/2 →
PASS-THROUGH WIDTH
STANDARD SLIDING REAR GATE
SHOWN WITH ROLLER GATE OPEN

OPTIONAL CONFIGURATIONS

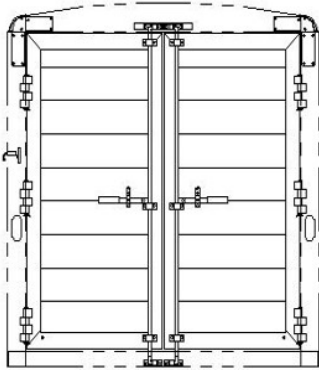

6'8" TALL, DOUBLE DOORS
REAR OPENING - 74 3/8W X 75T
CAM LATCH WITH STANDARD HINGES

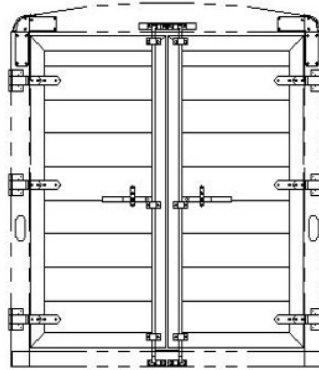

6'8" TALL, DOUBLE DOOR
REAR OPENING - 74 3/8W X 75T
CAM LATCH WITH LAY-FLAT HINGES

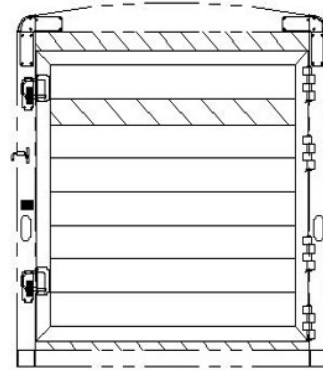

6'8" TALL, SOLID GATE
REAR OPENING - 76W X 76T

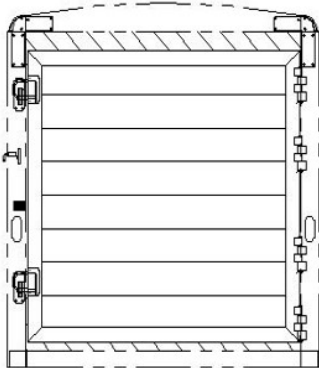

6'8" TALL, ENCLOSED SOLID GATE
REAR OPENING - 76W X 76T

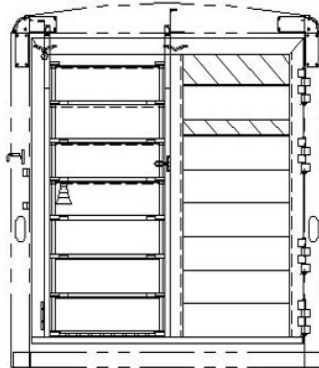

6'8" TALL, HALF ROLL-UP, 32 1/4" OPENING WIDTH
REAR OPENING - 76W X 76T

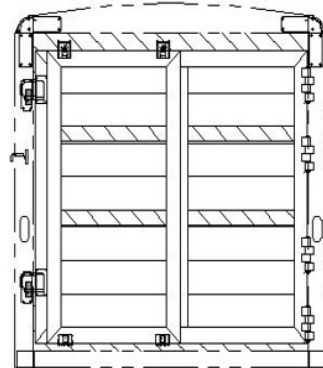

6'8" TALL, SLOTTED ROLLER GATE
REAR OPENING - 76W X 76T

REAR GATE CONFIGURATIONS, ENDURA STOCK TRAILERS 7W 7'4" T

STANDARD CONFIGURATION

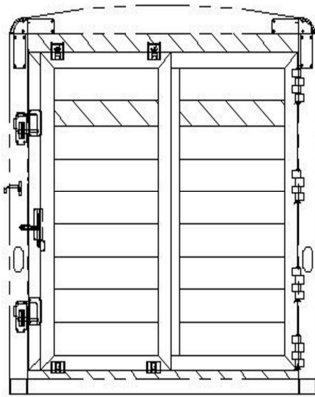

7'4" TALL, STANDARD LIVESTOCK SLIDER
REAR OPENING - 76W X 84T

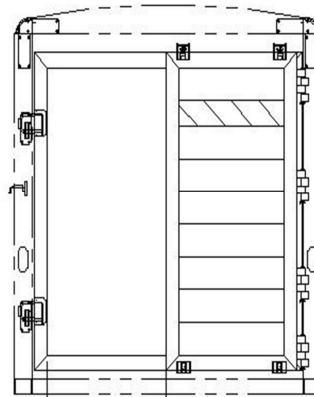

33 1/2"
PASS-THROUGH WIDTH
STANDARD SLIDING REAR GATE
SHOWN WITH ROLLER GATE OPEN

OPTIONAL CONFIGURATIONS

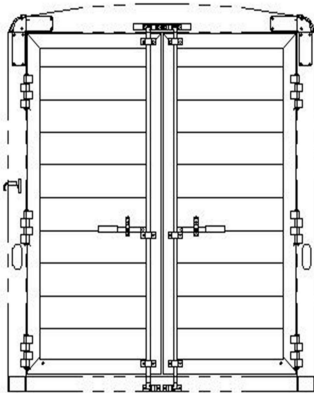

7'4" TALL, DOUBLE DOOR
REAR OPENING - 74 3/8W X 83T
CAM LATCH WITH STANDARD HINGES

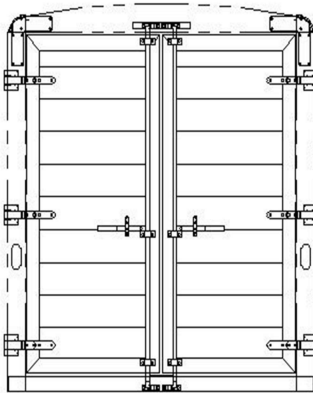

7'4" TALL, 7W, DOUBLE DOOR
REAR OPENING - 74 3/8W X 83T
CAM LATCH WITH LAY-FLAT HINGES

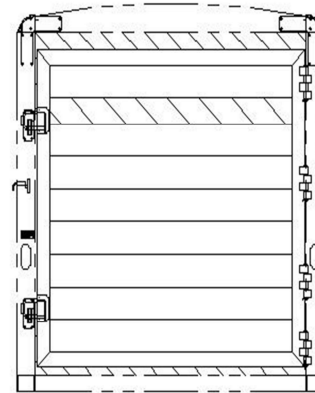

7'4" TALL, SOLID GATE
REAR OPENING - 76W X 84T

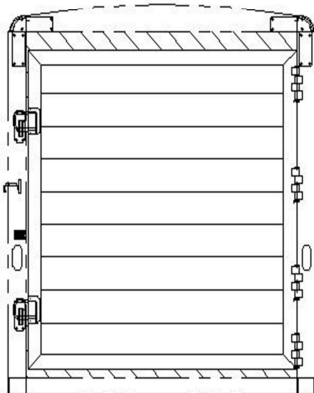

7'4" TALL, ENCLOSED SOLID GATE
REAR OPENING - 76W X 84T

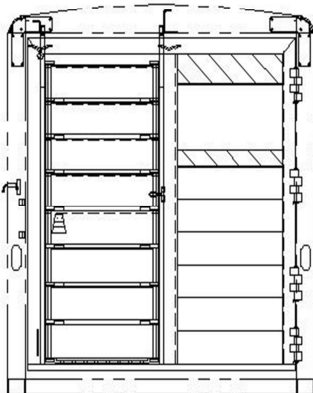

7'4" TALL, HALF ROLL-UP, 32 1/4" OPENING WIDTH
REAR OPENING - 76W X 84T

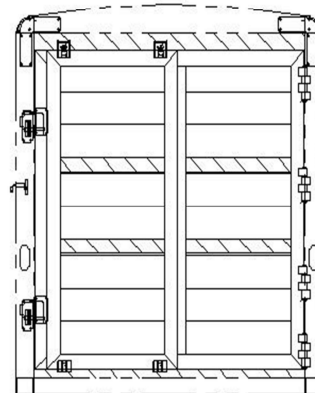

7'4" TALL, SLOTTED ROLLER GATE
REAR OPENING - 76W X 84T

REAR GATE CONFIGURATIONS, ENDURA STOCK TRAILERS 7'6"W 6'8"T

STANDARD CONFIGURATION

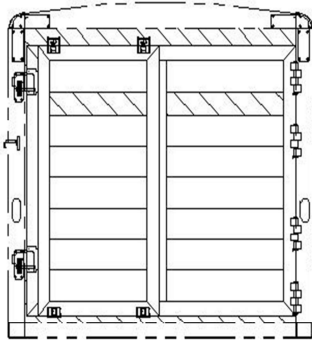

6'8" TALL, STANDARD LIVESTOCK SLIDER
REAR OPENING - 82W X 76T

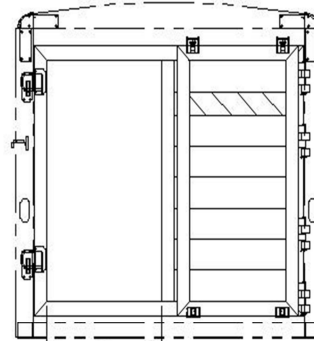

35
PASS-THROUGH WIDTH
STANDARD SLIDING REAR GATE
SHOWN WITH ROLLER GATE OPEN

OPTIONAL CONFIGURATIONS

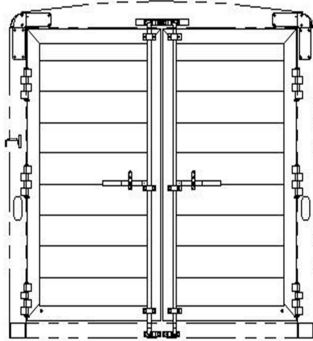

6'8" TALL, DOUBLE DOORS
REAR OPENING - 88 7/8W X 75T
CAM LATCH WITH STANDARD HINGES

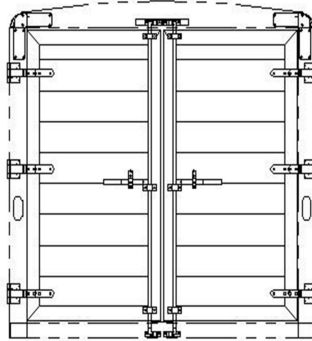

6'8" TALL, DOUBLE DOOR
REAR OPENING - 88 7/8W X 75T
CAM LATCH WITH LAY-FLAT HINGES

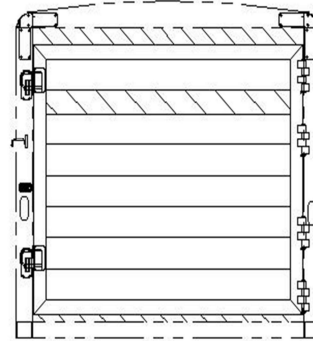

6'8" TALL, SOLID GATE
REAR OPENING - 82W X 76T

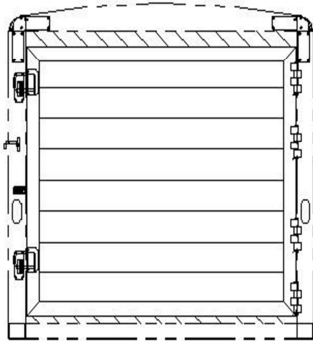

6'8" TALL, ENCLOSED SOLID GATE
REAR OPENING - 82W X 76T

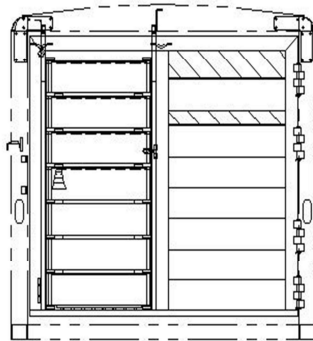

6'8" TALL, HALF ROLL-UP, 32 1/4" OPENING WIDTH
REAR OPENING - 82W X 76T

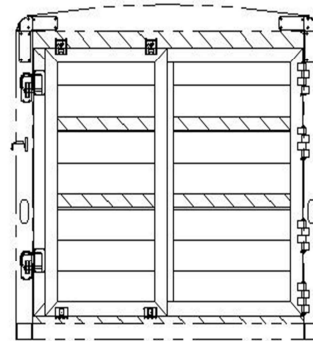

6'8" TALL, SLOTTED ROLLER GATE
REAR OPENING - 82W X 76T

REAR GATE CONFIGURATIONS, ENDURA STOCK TRAILERS 7'6"W 7'4"

STANDARD CONFIGURATION

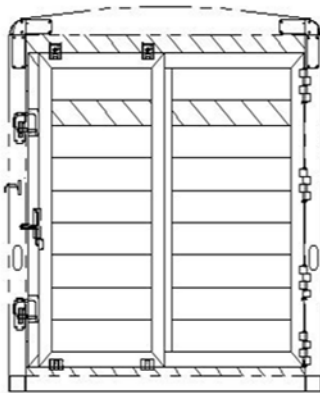

7'4" TALL, STANDARD LIVESTOCK SLIDER
REAR OPENING - 82W X 84T

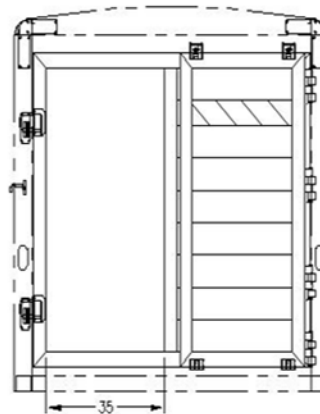

35
PASS-THROUGH WIDTH
STANDARD SLIDING REAR GATE
SHOWN WITH ROLLER GATE OPEN

OPTIONAL CONFIGURATIONS

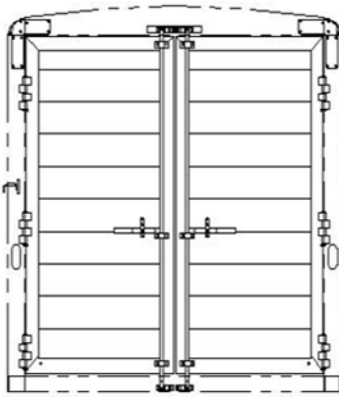

7'4" TALL, DOUBLE DOOR
REAR OPENING - 88 7/8W X 83T
CAM LATCH WITH STANDARD HINGES

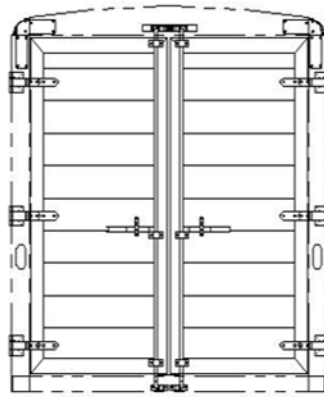

7'4" TALL, DOUBLE DOOR
REAR OPENING - 88 7/8W X 83T
CAM LATCH WITH LAY-FLAT HINGES

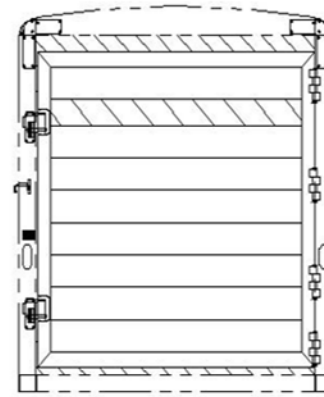

7'4" TALL, SOLID GATE
REAR OPENING - 82W X 84T

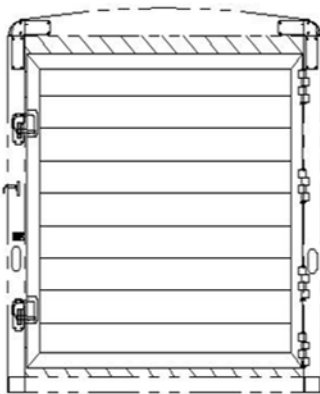

7'4" TALL, ENCLOSED SOLID GATE
REAR OPENING - 82W X 84T

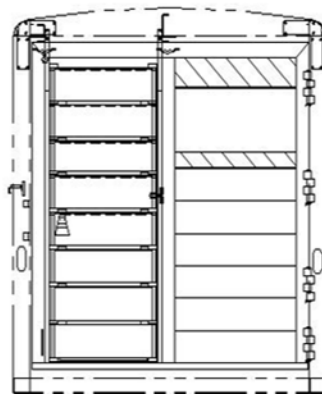

7'4" TALL, HALF ROLL-UP, 32 1/4" OPENING WIDTH
REAR OPENING - 82W X 84T

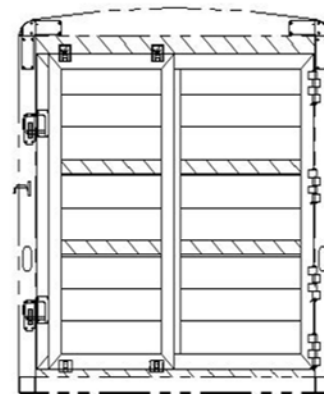

7'4" TALL, SLOTTED ROLLER GATE
REAR OPENING - 82W X 84T

REAR GATE CONFIGURATIONS, ENDURA STOCK TRAILERS 8'2"W 6'8"T

STANDARD CONFIGURATION

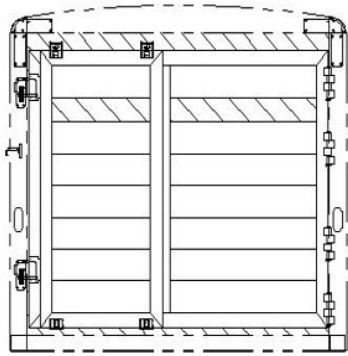

6'8" TALL, STANDARD LIVESTOCK SLIDER
REAR OPENING - 90 1/2" W X 76" T

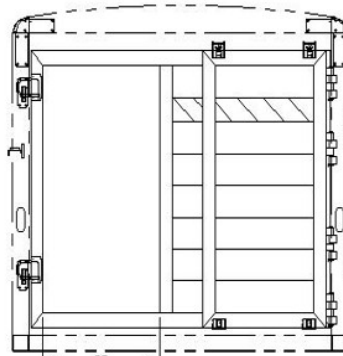

35
PASS-THROUGH WIDTH
STANDARD SLIDING REAR GATE
SHOWN WITH ROLLER GATE OPEN

OPTIONAL CONFIGURATIONS

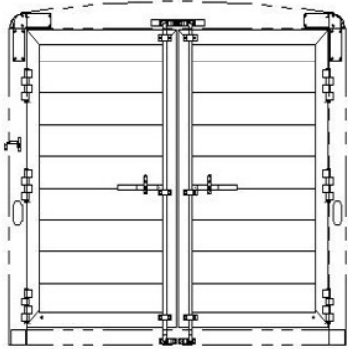

6'8" TALL, DOUBLE DOORS
REAR OPENING - 88 7/8" W X 75" T
CAM LATCH WITH STANDARD HINGES

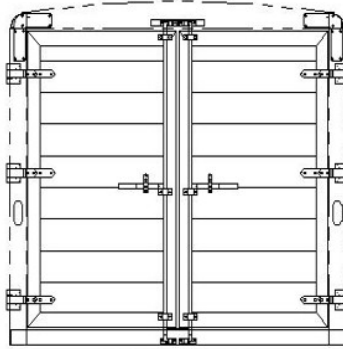

6'8" TALL, DOUBLE DOOR
REAR OPENING - 88 7/8" W X 75" T
CAM LATCH WITH LAY-FLAT HINGES

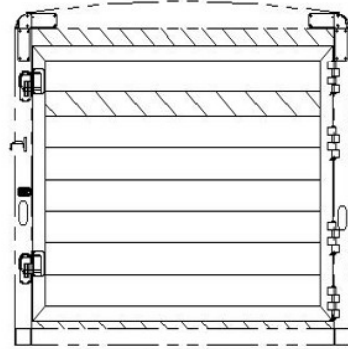

6'8" TALL, SOLID GATE
REAR OPENING - 90 1/2" W X 76" T

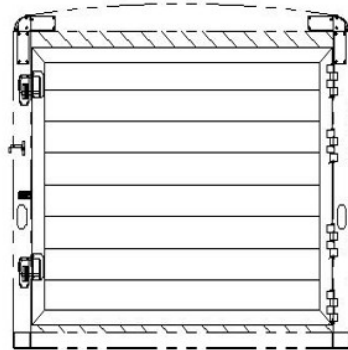

6'8" TALL, ENCLOSED SOLID GATE
REAR OPENING - 90 1/2" W X 76" T

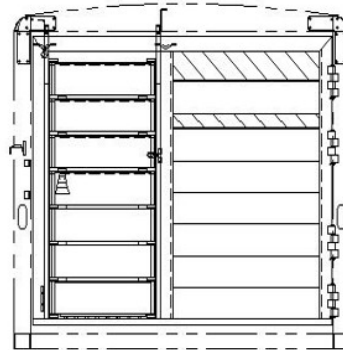

6'8" TALL, HALF ROLL-UP, 32 1/4" OPENING WIDTH
REAR OPENING - 90 1/2" W X 76" T

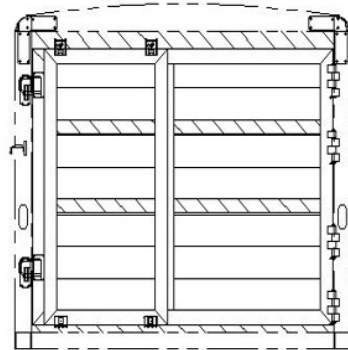

6'8" TALL, SLOTTED ROLLER GATE
REAR OPENING - 90 1/2" W X 76" T

REAR GATE CONFIGURATIONS, ENDURA STOCK TRAILERS 8'2"W 7'4"T

STANDARD CONFIGURATION

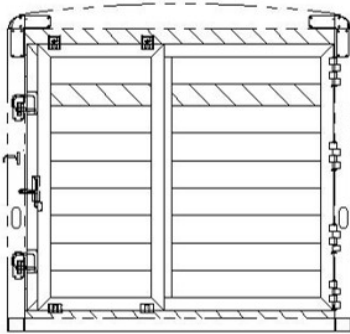

7'4" TALL, STANDARD LIVESTOCK SLIDER
REAR OPENING - 90 1/2W X 84T

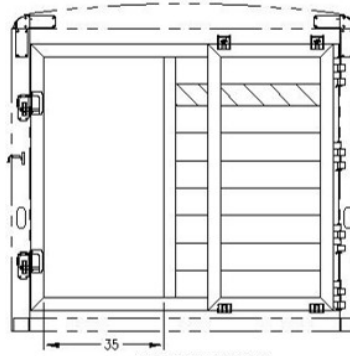

35
PASS-THROUGH WIDTH
STANDARD SLIDING REAR GATE
SHOWN WITH ROLLER GATE OPEN

OPTIONAL CONFIGURATIONS

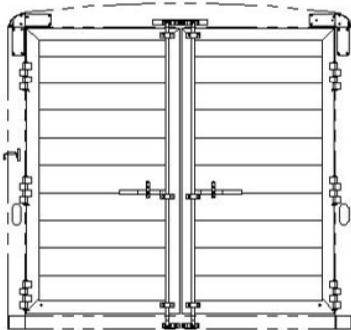

7'4" TALL, DOUBLE DOOR
REAR OPENING - 88 7/8W X 83T
CAM LATCH WITH STANDARD HINGES

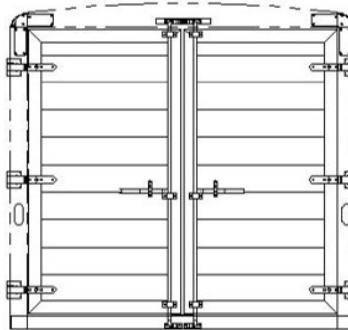

7'4" TALL, DOUBLE DOOR
REAR OPENING - 88 7/8W X 83T
CAM LATCH WITH LAT-FLAT HINGES

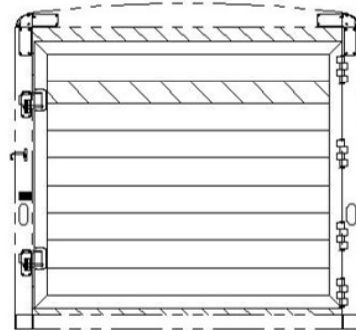

7'4" TALL, SOLID GATE
REAR OPENING - 90 1/2W X 84T

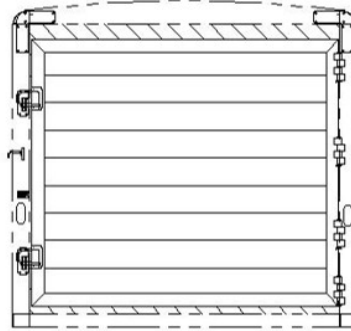

7'4" TALL, ENCLOSED SOLID GATE
REAR OPENING - 90 1/2W X 84T

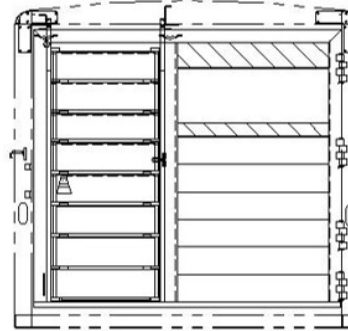

7'4" TALL, HALF ROLL-UP, 32 1/4" OPENING WIDTH
REAR OPENING - 90 1/2W X 84T

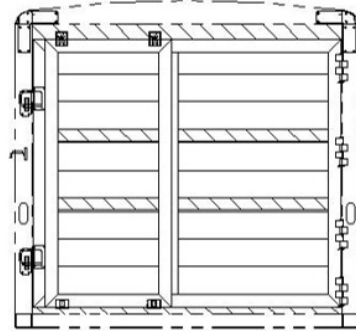

7'4" TALL, SLOTTED ROLLER GATE
REAR OPENING - 90 1/2W X 84T

ENDURA ALUMINUM TRAILER
 7' X 16' (3) HORSE COMBO
 6'8"/7'4" TALL

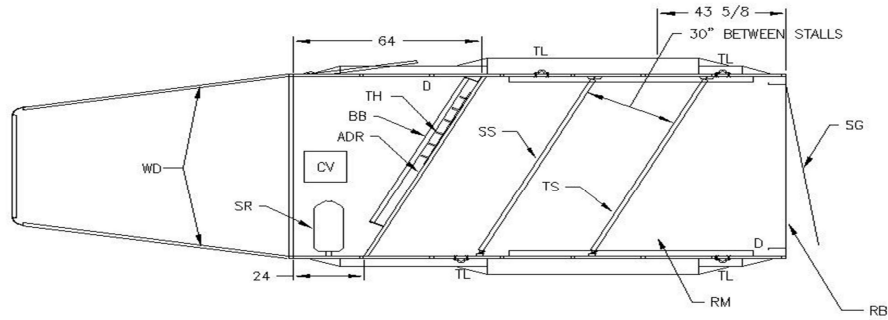

WD = 15 X 34 WINDOWS
 D = DOME LIGHTS (2)
 TL = TIE LOOPS (4) BOLT-ON
 BB = BLANKET BAR
 SG = SLIDING REAR GATE
 SS = SLANT STALL DIVIDER
 TS = TELESCOPING SLANT STALL DIVIDER

TH = TACK HOOKS
 SR = 3 PEDESTAL SADDLE RACK FOR 3 HORSE
 SR = 4 PEDESTAL SADDLE RACK FOR 4 HORSE
 CV = CRANK-UP ROOF VENT
 ADR = ANGLED DRESSING ROOM
 RB = RUBBER BUMPER
 RM = RUBBER MAT ON FLOOR

ENDURA ALUMINUM TRAILER
 7' X 20' (4) HORSE COMBO
 6'8"/7'4" TALL

