

### STANDARD EQUIPMENT

10 YEAR LIMITED WARRANTY  
 Gooseneck w/ Tapered Nose, Padlock Securable Gates, 37" Wide Escape Door,  
 Double Wall Sliding Center Gate w/ Slam Latch (2 Gates in 26' & Longer),  
 Double Wall Sliding Rear Gate w/Posi-Latch, Rubber Rollers on Sliding Gates,  
 Double Wall Smooth Extruded Sidewall, GN Compartment Fold Down Gate,  
 52" High Solid Sides on 6'8" Tall / 60" on 7'4" Tall, Adjustable GN Hitch Height,  
 Full Length Running Boards (on 7' & 7'5" Trailers Only), 2-5/16 Coupler, Rear Skid Plate,  
 Rear Rubber Bumper, Spare Tire Rack, Spare Tire & Wheel for Standard Axle,  
 Single 10K Spring Loaded Drop Leg Jack, Flat Floor w/ Traction Surface,  
 62" Truck Clearance, Graphics Package, Conspicuity Tape, Wrap Around Latch Rear Gate,  
 Heavy Duty Wiring Harness, Enclosed Brake Wiring, Safety Chains, One Piece Roof,  
 Quick Change Pigtail, 7-Way Plug, High Mount LED Stop, Turn, & Tail Lights,  
 Breakaway Battery w/ Charger & LED Dome Light (Switch on Light) in Front Compartment,  
 LED Lights, Front ID Lights, Rubber Torsion Axles w/ Spindle Lube 8-Bolt Hubs,  
 ST235/80R16 LR E Tires, 7K Axles w/ 12" x 2" Electric Brakes



## 6'8" TALL

ITEM	Column1	Column2	AXLE	WEIGHT(LBS)	GVWR	REF#	LIST PRICE
95036	ES7-16-68 GN Endura Stock F/G		2-7K	3735	14500	EN422NE70	\$ 29,182
95038	ES7-18-68 GN Endura Stock F/G		2-7K	3860	14500	EN332NE02	\$ 30,262
95040	ES7-20-68 GN Endura Stock F/G		2-7K	3985	14500	EN732NE64	\$ 30,862
95042	ES7-22-68 GN Endura Stock F/G		2-7K	4110	14500	EN242NE28	\$ 31,465
95044	ES7-24-68 GN Endura Stock F/G		2-7K	4235	14500	EN552NE24	\$ 33,148
95046	ES7-26-68 GN Endura Stock F/G		2-7K	4540	14500	EN272NE90	\$ 35,442
95048	ES7-28-68 GN Endura Stock F/G		2-7K	4665	14500	EN182NE95	\$ 36,617
95050	ES7-30-68 GN Endura Stock F/G		3-7K	5290	22610	EN223NE13	\$ 41,835
95052	ES7-32-68 GN Endura Stock F/G		3-7K	5415	22610	EN823NE97	\$ 42,723
95054	ES7-34-68 GN Endura Stock F/G		3-7K	5540	22610	EN533NE66	\$ 43,592

## 7'4" TALL

ITEM	Column1	Column2	AXLE	WEIGHT(LBS)	GVWR	REF#	LIST PRICE
95055	ES7-16-74 GN Endura Stock [OBS]		2-7K	3835	14500	EN212NE77	\$ 27,632
95057	ES7-18-74 GN Endura Stock F/G		2-7K	3970	14500	EN542NE35	\$ 31,864
95059	ES7-20-74 GN Endura Stock F/G		2-7K	4100	14500	EN942NE97	\$ 32,464
95061	ES7-22-74 GN Endura Stock F/G		2-7K	4235	14500	EN652NE37	\$ 33,295
95063	ES7-24-74 GN Endura Stock F/G		2-7K	4365	14500	EN462NE70	\$ 34,377
95065	ES7-26-74 GN Endura Stock F/G		2-7K	4680	14500	EN382NE48	\$ 36,816
95067	ES7-28-74 GN Endura Stock F/G		2-7K	4815	14500	EN192NE82	\$ 37,899
95069	ES7-30-74 GN Endura Stock F/G		3-7K	5445	22610	EN433NE59	\$ 43,453
95071	ES7-32-74 GN Endura Stock F/G		3-7K	5580	22610	EN643NE79	\$ 45,038
95073	ES7-34-74 GN Endura Stock [OBS]		3-7K	5710	22610	EN223NE09	\$ 41,830

### STANDARD EQUIPMENT

#### 10 YEAR LIMITED WARRANTY

Gooseneck w/ Tapered Nose, Padlock Securable Gates, 37" Wide Escape Door, Double Wall Sliding Center Gate w/ Slam Latch (2 Gates in 26' & Longer), Double Wall Sliding Rear Gate w/Posi-Latch, Rubber Rollers on Sliding Gates, Double Wall Smooth Extruded Sidewall, GN Compartment Fold Down Gate, 52" High Solid Sides on 6'8" Tall / 60" on 7'4" Tall, Adjustable GN Hitch Height, Full Length Running Boards (on 7' & 7'5" Trailers Only), 2-5/16 Coupler, Rear Skid Plate, Rear Rubber Bumper, Spare Tire Rack, Spare Tire & Wheel for Standard Axle, Single 10K Spring Loaded Drop Leg Jack, Flat Floor w/ Traction Surface, 62" Truck Clearance, Graphics Package, Conspicuity Tape, Wrap Around Latch Rear Gate, Heavy Duty Wiring Harness, Enclosed Brake Wiring, Safety Chains, One Piece Roof, Quick Change Pigtail, 7-Way Plug, High Mount LED Stop, Turn, & Tail Lights, Breakaway Battery w/ Charger & LED Dome Light (Switch on Light) in Front Compartment, LED Lights, Front ID Lights, Rubber Torsion Axles w/ Spindle Lube 8-Bolt Hubs, ST235/80R16 LR E Tires, 7K Axles w/ 12" x 2" Electric Brakes



### 6'8" TALL

ITEM	Column1	Column2	AXLE	WEIGHT(LBS)	GVWR	REF#	LIST PRICE
95300	ES7.5-16-68 GN Endura Stock F/G		2-7K	3860	14500	EN032NE96	\$ 29,995
95301	ES7.5-18-68 GN Endura Stock F/G		2-7K	3990	14500	EN042NE08	\$ 31,179
95302	ES7.5-20-68 GN Endura Stock F/G		2-7K	4120	14500	EN542NE48	\$ 31,881
95303	ES7.5-22-68 GN Endura Stock F/G		2-7K	4250	14500	EN052NE92	\$ 32,587
95304	ES7.5-24-68 GN Endura Stock F/G		2-7K	4380	14500	EN462NE67	\$ 34,373
95305	ES7.5-26-68 GN Endura Stock F/G		2-7K	4700	14500	EN382NE10	\$ 36,766
95306	ES7.5-28-68 GN Endura Stock F/G		3-7K	5330	22610	EN123NE22	\$ 41,717
95307	ES7.5-30-68 GN Endura Stock F/G		3-7K	5460	22610	EN333NE85	\$ 43,357
95308	ES7.5-32-68 GN Endura Stock F/G		3-7K	5590	22610	EN143NE47	\$ 44,347
95309	ES7.5-34-68 GN Endura Stock F/G		3-7K	5720	22610	EN843NE94	\$ 45,317

### 7'4" TALL

ITEM	Column1	Column2	AXLE	WEIGHT(LBS)	GVWR	REF#	LIST PRICE
95320	ES7.5-16-74 GN Endura Stock F/G		2-7K	3960	14500	EN342NE06	\$ 31,566
95321	ES7.5-18-74 GN Endura Stock F/G		2-7K	4100	14500	EN252NE38	\$ 32,777
95322	ES7.5-20-74 GN Endura Stock F/G		2-7K	4235	14500	EN752NE80	\$ 33,481
95323	ES7.5-22-74 GN Endura Stock F/G		2-7K	4375	14500	EN562NE00	\$ 34,416
95324	ES7.5-24-74 GN Endura Stock F/G		2-7K	4510	14500	EN472NE10	\$ 35,597
95325	ES7.5-26-74 GN Endura Stock F/G		2-7K	4840	14500	EN392NE66	\$ 38,138
95326	ES7.5-28-74 GN Endura Stock F/G		3-7K	5480	22610	EN133NE06	\$ 42,995
95327	ES7.5-30-74 GN Endura Stock F/G		3-7K	5615	22610	EN643NE33	\$ 44,978
95328	ES7.5-32-74 GN Endura Stock F/G		3-7K	5755	22610	EN953NE31	\$ 46,664
95329	ES7.5-34-74 GN Endura Stock F/G		3-7K	5890	22610	EN173NE80	\$ 48,286

### STANDARD EQUIPMENT

#### 10 YEAR LIMITED WARRANTY

Gooseneck w/ Tapered Nose, Padlock Securable Gates, 37" Wide Escape Door, Double Wall Sliding Center Gate w/ Slam Latch (2 Gates in 26' & Longer), Double Wall Sliding Rear Gate w/Posi-Latch, Rubber Rollers on Sliding Gates, Double Wall Smooth Extruded Sidewall, GN Compartment Fold Down Gate, 52" High Solid Sides on 6'8" Tall / 60" on 7'4" Tall, Adjustable GN Hitch Height, Rear Rubber Bumper, Spare Tire Rack, Spare Tire & Wheel for Standard Axle, Single 10K Spring Loaded Drop Leg Jack, Flat Floor w/ Traction Surface, 62" Truck Clearance, Graphics Package, Conspicuity Tape, Wrap Around Latch Rear Gate, Heavy Duty Wiring Harness, Enclosed Brake Wiring, Safety Chains, One Piece Roof, Quick Change Pigtail, 7-Way Plug, High Mount LED Stop, Turn, & Tail Lights, Breakaway Battery w/ Charger & LED Dome Light (Switch on Light) in Front Compartment, LED Lights, Front ID Lights, Rubber Torsion Axles w/ Spindle Lube 8-Bolt Hubs, ST235/80R16 LR E Tires, 7K Axles w/ 12" x 2" Electric Brakes, 2-5/16 Coupler, Rear Skid Plate



### 6'8" TALL

ITEM	Column1	Column2	AXLE	WEIGHT(LBS)	GVWR	REF#	LIST PRICE
95078	ES8-20-68 GN Endura Stock F/G		2-7K	4440	14500	EN452NE51	\$ 33,053
95080	ES8-22-68 GN Endura Stock F/G		2-7K	4575	14500	EN062NE80	\$ 33,870
95082	ES8-24-68 GN Endura Stock F/G		2-7K	4710	14500	EN472NE06	\$ 35,592
95084	ES8-26-68 GN Endura Stock F/G		3-7K	5545	22610	EN123NE58	\$ 41,764
95086	ES8-28-68 GN Endura Stock F/G		3-7K	5680	22610	EN233NE18	\$ 43,140
95088	ES8-30-68 GN Endura Stock F/G		3-7K	5815	22610	EN543NE60	\$ 44,883
95090	ES8-32-68 GN Endura Stock F/G		3-7K	5950	22610	EN453NE02	\$ 45,977
95092	ES8-34-68 GN Endura Stock F/G		3-7K	6085	22610	EN263NE25	\$ 47,045

### 7'4" TALL

ITEM	Column1	Column2	AXLE	WEIGHT(LBS)	GVWR	REF#	LIST PRICE
95097	ES8-20-74 GN Endura Stock F/G		2-7K	4555	14500	EN562NE63	\$ 34,497
95099	ES8-22-74 GN Endura Stock F/G		2-7K	4700	14500	EN372NE61	\$ 35,534
95101	ES8-24-74 GN Endura Stock F/G		2-7K	4840	14500	EN382NE48	\$ 36,816
95103	ES8-26-74 GN Endura Stock F/G		3-7K	5685	22610	EN233NE12	\$ 43,132
95105	ES8-28-74 GN Endura Stock F/G		3-7K	5830	22610	EN243NE04	\$ 44,421
95107	ES8-30-74 GN Endura Stock F/G		3-7K	5970	22610	EN853NE08	\$ 46,504
95109	ES8-32-74 GN Endura Stock F/G		3-7K	6115	22610	EN173NE84	\$ 48,291
95111	ES8-34-74 GN Endura Stock F/G		3-7K	6255	22610	EN583NE10	\$ 50,013

**STANDARD EQUIPMENT**

10 YEAR LIMITED WARRANTY  
 2' V Nose (In Addition to Floor Length), Padlock Securable Gates, 37" Wide Escape Door,  
 Double Wall Sliding Center Gate w/ Slam Latch, 7' Inside Width, 2,000# Sidewind Jack,  
 Double Wall Sliding Rear Gate w/Posi-Latch, Rubber Rollers on Sliding Gates,  
 Double Wall Smooth Extruded Sidewall, Full Length Running Boards,  
 52" High Solid Sides on 6'8" Tall / 60" on 7'4" Tall, Flat Floor w/ Traction Surface,  
 Rear Rubber Bumper, Spare Tire Rack, Spare Tire & Wheel for Standard Axle,  
 Graphics Package, Conspicuity Tape, Wrap Around Latch Rear Gate,  
 Heavy Duty Wiring Harness, Enclosed Brake Wiring, Safety Chains, One Piece Roof,  
 Quick Change Pigtail, 7-Way Plug, High Mount LED Stop, Turn, & Tail Lights,  
 Breakaway Battery w/ Charger, LED Dome Light (Switch on Light) in Front Compartment,  
 LED Lights, Rubber Torsion Axles w/ Spindle Lube 8-Bolt Hubs,  
 ST235/80R16 LR E Tires, 7K Axles w/ 12" x 2" Electric Brakes, 2-5/16 Coupler, Rear Skid Plate



**6'8" TALL**

ITEM	Column1	Column2	AXLE	WEIGHT(LBS)	GVWR	REF#	LIST PRICE
95359	ES7-14-68 BH Endura Stock F/G		2-7K	3085	14500	EN781NE69	\$ 24,375
95360	ES7-16-68 BH Endura Stock F/G		2-7K	3210	14500	EN491NE90	\$ 25,312
95361	ES7-18-68 BH Endura Stock F/G		2-7K	3395	14500	EN202NE09	\$ 26,245

**7'4" TALL**

ITEM	Column1	Column2	AXLE	WEIGHT(LBS)	GVWR	REF#	LIST PRICE
95363	ES7-14-74 BH Endura Stock F/G		2-7K	3175	14500	EN391NE73	\$ 25,160
95364	ES7-16-74 BH Endura Stock F/G		2-7K	3310	14500	EN102NE78	\$ 26,205
95365	ES7-18-74 BH Endura Stock F/G		2-7K	3445	14500	EN902NE81	\$ 27,248

## ENDURA STOCK AXLE/BRAKE/TIRE OPTIONS

### OPTIONS FOR (2) 7K RUBBER TORSION AXLES W/ST235/85R16E TIRES

ITEM			REF#	LIST PRICE
X9135	7K AXLE (2) RUBBER TORSION, 8-BOLT HUB	235/75R17.5 LRJ, 14500 GVWR	AL720SO54	\$ 3,577
X9062	7K AXLE (3), RUBBER TORSION ILOS (2)7K	ST235/80R16 LRE, 22610 GVWR	AL820SO44	\$ 3,694
X9064	7.2K AXLE (2), RUBBER TORSION ILOS (2)7K	ST235/80R16 LRE, 15000 GVWR	AL210SO24	\$ 1,590
X9063	8K AXLE (2), RUBBER TORSION ILOS (2)7K	ST235/85R16 LRG, 17500 GVWR	AL030SO79	\$ 3,999
X9066	8K AXLE (2), RUBBER TORSION ILOS (2)7K	235/75R17.5 LRJ, 17500 GVWR	AL840SO61	\$ 6,313
X9065	10K AXLE (2), RUBBER TORSION ILOS (2)7K	235/75R17.5 LRJ, 22610 GVWR	AL560SO18	\$ 8,465

### OPTIONS FOR (3) 7K RUBBER TORSION AXLES W/ST235/85R16 LRE TIRES

ITEM			REF#	LIST PRICE
X9136	7K AXLE (3) RUBBER TORSION	235/75R17.5 LRJ, 22610 GVWR	AL730SO94	
X9068	8K AXLES (2), RUBBER TORSION ILOS (3)7K	ST235/85R16 LRG, 17500 GVWR	AL400SO20	\$ 545
X9132	8K AXLES (2) ILOS (3)7K AXLES	235/75R17.5 LRJ, 17500 GVWR	AL220SO05	\$ 2,864
X9069	10K AXLES (2), RUBBER TORSION ILOS (3)7K	235/75R17.5 LRJ, 35900 GVWR	AL930SO35	\$ 5,110

### BRAKES

ITEM		REF#	LIST PRICE
X9070	ELECTRIC/HYDRAULIC BRAKES, ILOS 2 ELECT	BR820BR65	\$ 3,721
X9071	ELECTRIC/HYDRAULIC BRAKES, ILOS 3 ELECT	BR230BR45	\$ 4,214

### TIRE/WHEEL OPTIONS (ILOS)

ITEM			REF#	LIST PRICE
X9072	T/W ST235/85R 16 LR G ILOS 16E	Westlake	AL100SO69	\$ 219
X9074	T/W 235/75R 17.5 LR J ILOS 16E	Westlake	AL200SO85	\$ 370

### TIRE/WHEEL OPTIONS (ADDITIONAL SPARE)

ITEM			REF#	LIST PRICE
234294	TIRE & WHEEL ST235/80R16E W/SL MOD LION	Castle Rock	TI200WH04	\$ 265
234296	TIRE & WHEEL ST235/85R16G W/SL MOD LION	Westlake	TI300WH42	\$ 444
234398	TIRE & WHEEL 235/75R17.5J W/SL MOD LION	Westlake	TI400WH82	\$ 626
X9076	ALUMINUM SPOKE T/W ILOS 16" WHEEL	*price per wheel	AL200SO09	\$ 271
X9075	ALUM WHEEL ILOS 17.5 J WHEEL	*price per wheel	AL200SO09	\$ 271

# ENDURA STOCK ACCESSORIES AND OPTIONS

## BODY & FRAME OPTIONS

ITEM			REF#	LIST PRICE
X9003	3" SLOTTED SIDES (28" FROM FLOOR)	<i>per Trailer</i>	AL200SO22	\$ 288
X9001	FRONT VENT & COVER		AL300SO46	\$ 449
X9004	TIE RAIL (INSIDE OR OUTSIDE)	<i>per ft.</i>	AL000SO26	\$ 34
231744	TIE LOOP CAST AL	<i>Bolt-On, External (price each)</i>	MI000 P40	\$ 52
89321	TIE LOOP, 1/2" AL ROUND X 7-1/2"	<i>Weld-On, Internal (price each)</i>	AL000 P23	\$ 30
X9007	DUAL JACK, SINGLE SPEED ILOS	<i>Gooseneck Only</i>	AL300SO27	\$ 425
X9008	DUAL JACK, 2 SPD GEARBOX ILOS	<i>Gooseneck Only</i>	AL600SO76	\$ 878
X9009	12K ELECT/HYD BIG FOOT JACK ILOS	<i>Gooseneck Only, Includes Battery</i>	AL620SO58	\$ 3,452

## ESCAPE DOOR & SIDE RAMP OPTIONS (14,500 GVWR)-Restrictions may apply to placement

ITEM			REF#	LIST PRICE
X9016	ADDITIONAL 37" ESCAPE DOOR, EITHER SIDE		AL700SO69	\$ 999
X9127	52" WIDE ESCAPE DOOR, ADDITIONAL		AL010SO23	\$ 1,329
X9013	52" WIDE ESCAPE DOOR ILOS		AL200SO62	\$ 340
X9128	52" WIDE ESCAPE DOOR, NO SILL, ILOS 37"		AL110SO22	\$ 1,457
X9129	52" WIDE ESCAPE DOOR, NO SILL, ADD		AL810SO85	\$ 2,448
X9015	52" WIDE FOLD DOWN SIDE RAMP		AL220SO19	\$ 2,882
X9014	52" WIDE FOLD DOWN SIDE RAMP ILOS		AL410SO59	\$ 1,895
X9130	52"W FOLD DOWN SIDE RAMP, NO SILL, ADD		AL030SO79	\$ 3,999
X9131	52"W FOLD DOWN SIDE RAMP, NO SILL, ILOS		AL320SO20	\$ 3,013
X9017	FULLY ENCLSD LIVESTOCK ESCAPE DOOR ILOS		AL100SO53	\$ 199

\*\*LIMITED TO 14,500 GVWR when used in Addition to 37" or 52" Wide Escape Door

\*Larger than 14,500 GVWR or 2-7K axles-call sales for additional frame structure pricing\*

## CENTER GATE OPTIONS

ITEM			REF#	LIST PRICE
X9020	DELETE SLIDING CENTER GATE & POSTS		AL00-SO73	\$ (573)
X9021	MOVE CENTER GATE FROM STANDARD POSITION		AL200SO08	\$ 270
X9022	ADJ SOLID CNTR GATE ILOS, NO SLIDER		AL310SO30	\$ 1,727
X9023	ADJ SOLID CNTR GATE, NO SLIDER		AL620SO55	\$ 3,448
X9134	ADJ SLIDING CNTR GATE ILOS		AL510SO64	\$ 2,031
x9133	ADJ SLIDIING CNTR GATE		AL820SO88	\$ 3,751
X9002	ADD SLIDING CENTER GATE		AL310SO27	\$ 1,723
X9024	SOLID CENTER GATE ILOS		AL000SO00	\$ -
X9025	ADDITIONAL SOLID CENTER GATE		AL110SO28	\$ 1,465
X9026	ADDITIONAL SET OF CENTER GATE POSTS		AL400SO52	\$ 587
X9027	3" SLOT IN CENTER GATE		AL000SO86	\$ 112
X9140	PEN (1 PAIR, 4' LONG)		AL310SO94	\$ 1,810

## REAR GATE OPTIONS (ILOS)

ITEM			REF#	LIST PRICE
X9028	SOLID REAR GATE (NON-SLIDING)	<i>w/ Standard L.S. Opening</i>	AL000SO00	\$ -
X9029	ENCLOSED SOLID (NON-SLIDING) REAR GATE		AL000SO00	\$ -
X9030	1/2 ROLL-UP DOOR IN LIVESTOCK REAR GATE		AL700SO18	\$ 932
X9031	3" SLOT IN REAR GATE		AL000SO86	\$ 112
X9032	DOUBLE REAR DOORS WITH CAM LATCH		AL200SO57	\$ 334
X9033	DBL REAR DOORS W/ FOLD AROUND HINGES	<i>Lay Flat Hinges</i>	AL600SO64	\$ 862
X9137	4' REAR RAMP BEHIND REAR GATE		AL520SO87	\$ 3,360

\*\*ALL PRICES SUBJECT TO CHANGE, FINAL PRICING WILL BE CONFIRMED THROUGH ORDER VERIFICATION\*\*

\*\*PRICE EFFECTIVITY IS BASED ON ECD OF ORDER\*\*

<b>GN COMPARTMENT GATES &amp; DOORS</b>				
ITEM			REF#	LIST PRICE
X9010	GN SLAM DOOR W/ LOCK	Available on Both Sides	AL400SO28	\$ 556
X9011	WINDOW IN GOOSENECK COMPARTMENT 15X34	Available on Both Sides	AL200SO53	\$ 329
X9012	GN SLAM DOOR WITH LOCK ON FRONT OF NOSE	Drop Down	AL600SO64	\$ 862
X9018	EZ STORE RAMPS ILOS FOLD DOWN GN GATE		AL300SO25	\$ 422

<b>DOUBLE DECK OPTIONS</b>				
ITEM			REF#	LIST PRICE
X9036	DOUBLE DECK RAIL, PER FT. OF TRAILER		AL000SO37	\$ 48
X9037	SPLIT SLIDING CENTER GATE ILOS		AL500SO75	\$ 747
X9038	SPLIT SLIDING REAR GATE ILOS		AL500SO75	\$ 747
X9039	SPLIT ESCAPE DOOR		AL100SO66	\$ 216
X9040	DOUBLE DECK FLOORING, 7' WIDTH, PER FT	weight rating 70lbs per sqft per ft	AL100SO25	\$ 162
X9041	DOUBLE DECK FLOORING, 8' WIDTH, PER FT	weight rating 70lbs per sqft per ft	AL100SO39	\$ 181

**\*\* weight rating 70lbs per sqft per ft**

<b>LIGHTING OPTIONS</b>				
ITEM			REF#	LIST PRICE
X9042	LED LOADING LIGHT - REQUIRES SWITCH	1900 Lumens	AL100SO58	\$ 205
X9043	RECESSED TOGGLE SWITCH - DOME OR LOAD		AL000SO53	\$ 69
X9045	EXTRA LED CLEARANCE LIGHTS (PER PAIR)		AL000SO62	\$ 81
X9046	RECESSED 3 WAY TOGGLE SWITCH	Requires 2	AL000SO66	\$ 86
X9047	LED BACK UP LIGHTS (PER PAIR)		AL300SO27	\$ 425
X9048	LED DOME LIGHT		AL000SO66	\$ 86

<b>VENTS</b>				
ITEM			REF#	LIST PRICE
X9049	CRANK-UP ROOF VENT		AL100SO64	\$ 213
X9050	DRAFT/EXHAUST (POP-UP) ROOF VENT		AL100SO51	\$ 196

<b>RUBBER MAT (Add rubber matting cost and installation cost)</b>				
ITEM			REF#	LIST PRICE
X9051	1/2"X60"X84" RUBBER MATTING	per Sheet	AL100SO61	\$ 209
X9052	3/4"X60"X84" RUBBER MATTING	per Sheet	AL100SO91	\$ 248
X9053	INSTALLATION OF MATTING FOR 7.0' TRAILER		AL200SO00	\$ 260
X9054	INSTALLATION OF MATTING FOR 7.5' AND 8.0		AL300SO17	\$ 412

<b>PLEXI-GLASS &amp; STORAGE</b>				
ITEM			REF#	LIST PRICE
91899	ENDURA PLEXIGLASS HARDWARE KIT		KI100KI31	\$ 170
233851	PLEXIGLASS STRIP 3/16 X 7-3/16 X 96 BRNZ	Sold in 8' Lengths	MI000 P59	\$ 77
X9035	PLEXI-GLASS INSTALLED AT HILLSBORO	per ft.	AL000SO69	\$ 90
X9034	PLEXI-GLASS STORAGE TRAY	GN or Straight Hitch Trailer	AL400SO18	\$ 543

**\*\* Plexi-Glass Install Kit Includes: 50 retention plugs, 14 filler end pieces, 1 drill guide, and installation instructions**

**\*\*\* Plexi-Glass Installed per foot of trailer, Includes 2 slots left side, 2 slots right side, escape door & rear gate**

**\*\*\*\* Pricing = MSRP \* Length(feet) of Trailer, Includes 2 slots left side, 2 slots right side, escape door & rear gate**

<b>COMBO ROOF COVE &amp; GOOSENECK NOSE BLACK</b>				
ITEM			REF#	LIST PRICE
X9056	(1) PAINT ROOF COVE - BLACK	(Trailer + Nose Length) * MSRP = Price	AL000SO38	\$ 49
X9057	(2) PAINT GOOSENECK NOSE BLACK	Includes Nose and Sides	AL500SO20	\$ 675

**\*\* example (1)+(2) :7x20+8' nose = (28 ft total trailer x \$49= \$1372)+(\$675) = \$2047**

<b>PAINT ROOF COVE /ft of total trailer length (include gooseneck &amp; 2' V-Nose)</b>				
ITEM			REF#	LIST PRICE
X9055	PAINT ROOF COVE - BLACK	(Trailer + Nose Length) * MSRP = Price	AL000SO38	\$ 49

**\*\* Example: SH 7x18 + 2' v-Nose = 20 ft total trailer X \$49 = \$980**

# ENDURA LIVESTOCK AND COMBO OPTIONS

## BODY & FRAME OPTIONS

ITEM			REF#	LIST PRICE
X9077	FULLY ENCLOSE SIDE (PER FT)	<i>per ft./ per side</i>	AL000SO67	\$ 87

## DRESSING ROOM OPTIONS (d/r)

ITEM			REF#	LIST PRICE
X9078	ANGLED D/R W/ SEALED DOOR, 2; SHORT WALL	<i>Deletes Escape Door</i>	AL710SO09	\$ 2,219
X9079	4' RECTANGULAR D/R W/ SEALED D/R DOOR	<i>Deletes Escape Door</i>	AL710SO09	\$ 2,219
X9080	SLIDE OUT CAMPER STEP - D/R DOOR	<i>N/A on 8' W Trailer</i>	AL200SO69	\$ 349
X9081	SADDLE RACK, 2 PEDESTAL		AL500SO30	\$ 688
X9082	SADDLE RACK, 3 PEDESTAL		AL600SO53	\$ 848
X9083	SADDLE RACK, 4 PEDESTAL		AL700SO81	\$ 1,014
X9084	TACK HOOKS, BAR OF 6		AL000SO76	\$ 99
X9085	BRUSH TRAY - SPECIFY PLACEMENT		AL000SO80	\$ 104
X9086	BLANKET BAR		AL000SO66	\$ 86
X9088	WALK THROUGH DOOR FROM D/R TO LIVESTOCK		AL600SO94	\$ 901

## LIVESTOCK/HORSE COMPARTMENT OPTIONS

ITEM			REF#	LIST PRICE
X9089	SLANT STALL DIVIDER, PADDED		AL800SO19	\$ 1,064
X9090	SLANT STALL DIVIDER, PADDED, TELESCOPING		AL110SO36	\$ 1,475
X9091	FULL SLANT STALL DIVIDER/STUD GATE ILOS		AL110SO15	\$ 1,448
X9092	PADDING ON LIVESTOCK SIDE OF ANGLE WALL		AL100SO04	\$ 135
X9093	KICK PANEL - RUBBER 48" HEIGHT	<i>Head Side, per ft.</i>	AL000SO74	\$ 96
94263	BOLT-ON TIE LOOP PACKAGE	<i>External (price each)</i>	EN000NE40	\$ 52
89321	TIE LOOP, 1/2" AL ROUND X 7-1/2"	<i>Weld-On, Internal (price each)</i>	AL000 P23	\$ 30
X9004	TIE RAIL (INSIDE OR OUTSIDE)	<i>per ft.</i>	AL000SO26	\$ 34

## WINDOWS

ITEM			REF#	LIST PRICE
X9011	WINDOW IN GOOSENECK COMPARTMENT 15X34	<i>Available on Both Sides</i>	AL200SO53	\$ 329
X9095	SIDE WINDOW 14X21		AL200SO18	\$ 283

## ENDURA PLEX USAGE

## ENDURA RUBBER MAT USAGE

2 Slot includes Escape Door & Rear Gate / 3 Slot includes slotted Escape Door & Slotted Rear Gate

# SLOTS	Length	# of 7-3/16 strip	# of 4-7/16	Length	7' W	7.5' W	8' W
2	16	9	-	16	3.2	3.5	3.8
2	18	10	-	18	3.6	4	4.3
2	20	11	-	20	4	4.5	4.8
2	22	12	-	22	4.4	5	5.3
2	24	13	-	24	4.8	5.5	5.8
2	26	14	-	26	5.2	6	6.3
2	28	15	-	28	5.6	6.5	6.8
2	30	16	-	30	6	7	7.3
2	32	17	-	32	6.4	7.5	7.8
2	34	18	-	34	6.8	8	8.3
3	9	5	5				
3	10	5.5	5.5				
3	11	6	6				
3	12	6.5	6.5				
3	13	7	7				
3	14	7.5	7.5				
3	15	8	8				
3	16	8.5	8.5				
3	17	9	9				
3	18	9.5	9.5				

## ENDURA STANDARD GATE PLACEMENTS

\*Note: To get exact compartment sizes, the thickness of the gates must be deducted. The thickness of a sliding center gate is approximately 4".

Goosenecks	Length	Gates	Compartments	Compartment sizes			Front Compartment with adjustable position from
				Front	Middle	Rear	
	16'	1	2	6' 11"	n/a	9' 1"	n/a
	18'	1	2	8' 5"	n/a	9' 7"	n/a
	20'	1	2	9' 5"	n/a	10' 7"	8'
	22'	1	2	10' 5"	n/a	11' 7"	8'
	24'	1	2	11' 11"	n/a	12' 1"	10'
	24'	2	3	8'	8'	8'	10'
	26'	2	3	8' 8"	8' 8"	8' 8"	10'
	28'	2	3	9' 4"	9' 4"	9' 4"	12'
	30'	2	3	10'	10'	10'	12'
	32'	2	3	10' 8"	10' 8"	10' 8"	12'
	34'	2	3	11' 4"	11' 4"	11' 4"	12'
Straigh Hitch	Length	Gates	Compartments	Compartment sizes			Front Compartment with adjustable position from
				Front	Middle	Rear	
	14'	1	2	7'	n/a	7'	n/a
	16'	1	2	8'	n/a	8'	n/a

## ENDURA PAINT & POLISH OPTIONS

GREEN = PAINT

OPTION 1: PAINT ROOF COVE BLACK  
INCLUDES SIDES AND FRONT

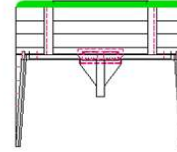
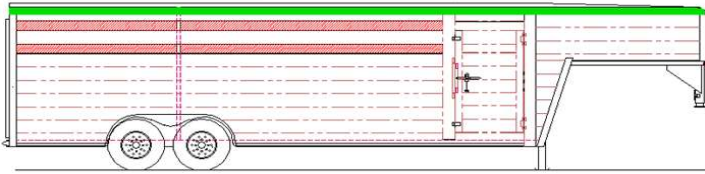

OPTION 2: PAINT NOSE BLACK  
INCLUDES SIDES AND FRONT

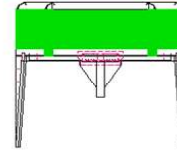
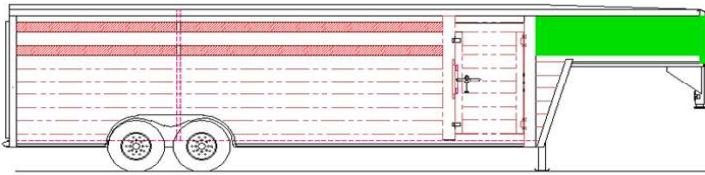

OPTION 3: PAINT ROOF COVE AND NOSE BLACK  
COMBINE COST OF OPTION 1 AND OPTION 2 FOR DEALER COST

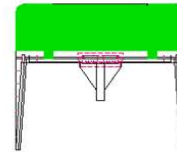

TITLE <b>PAINT OPTIONS</b>					<i>Hillsboro Industries</i> 220 Industrial Road Hillsboro, KS 67063		1-800-835-0209 hi@hillsboroindustries.com www.hillsboroindustries.com	
DWG NO.	REV <b>A</b>	DATE <b>12-7-16</b>	DRAWN BY <b>APD</b>	SCALE <b>1/60</b>				

## ENDURA PAINT & POLISH OPTIONS

GREEN = PAINT

YELLOW = TREAD PLATE

OPTION 1: PAINT ROOF COVE BLACK

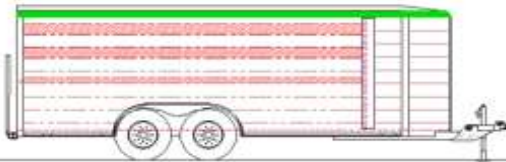

OPTION 7: PAINT ROOF COVE, AND CORNER COVE BLACK  
SHOWN WITH OPTIONAL POLISHED V-NOSE AND ROCK GUARD



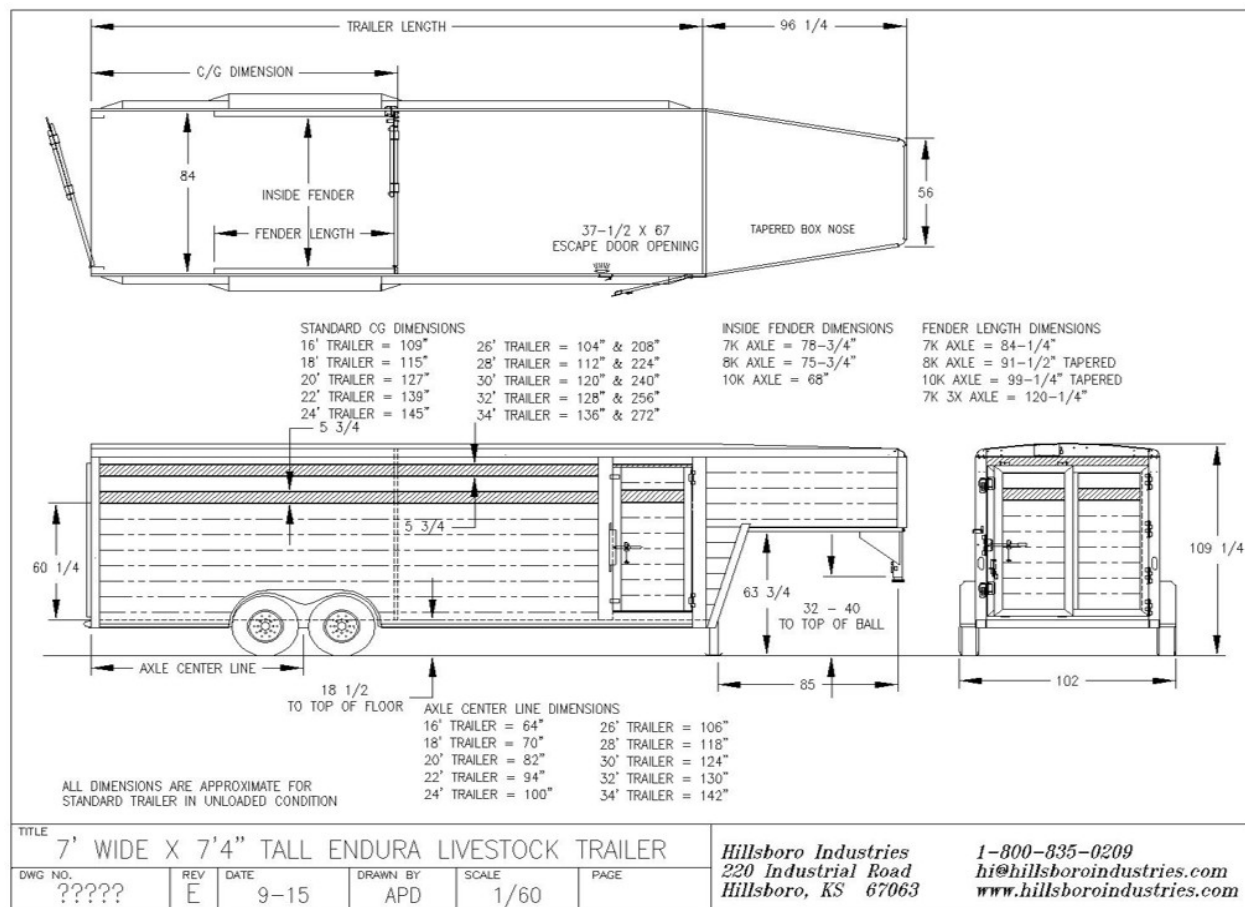
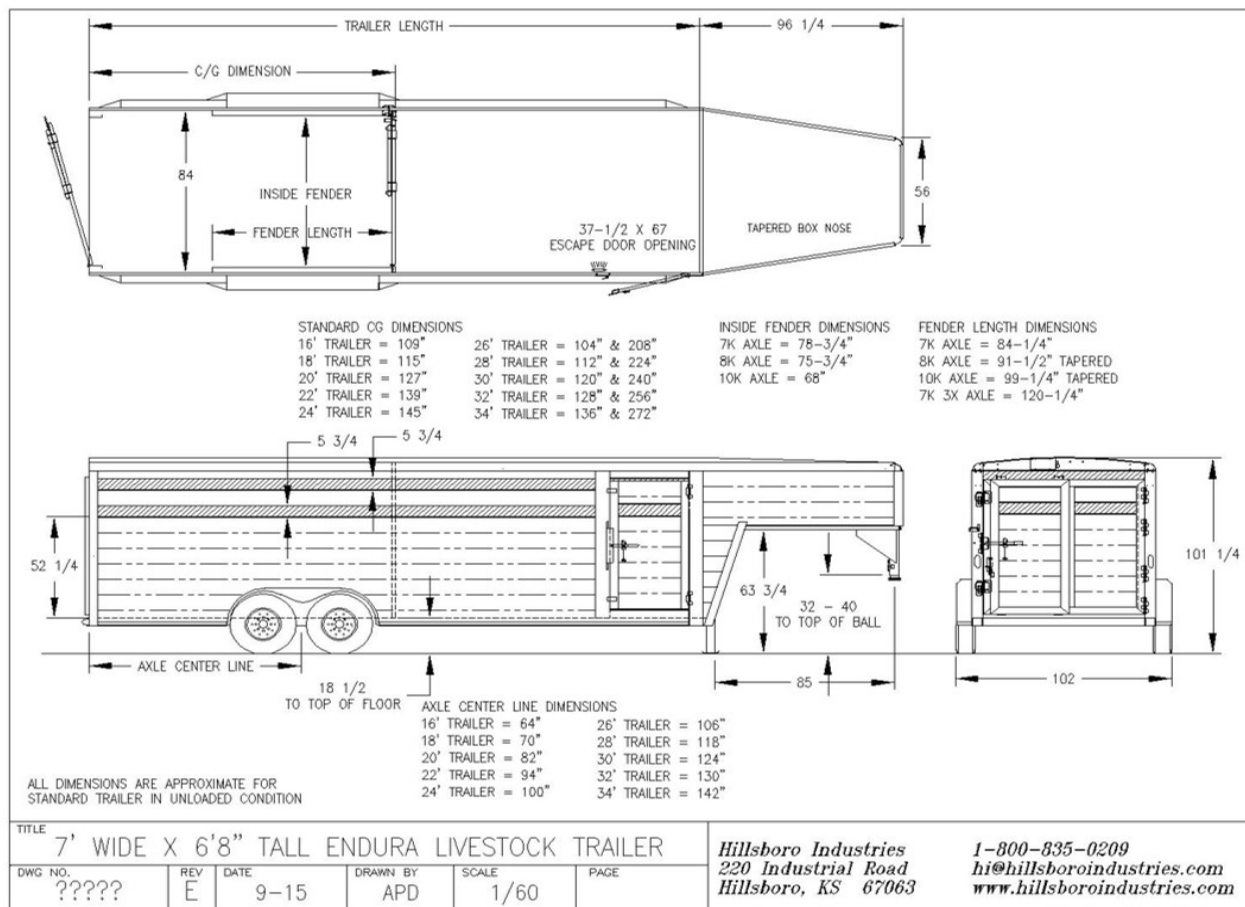

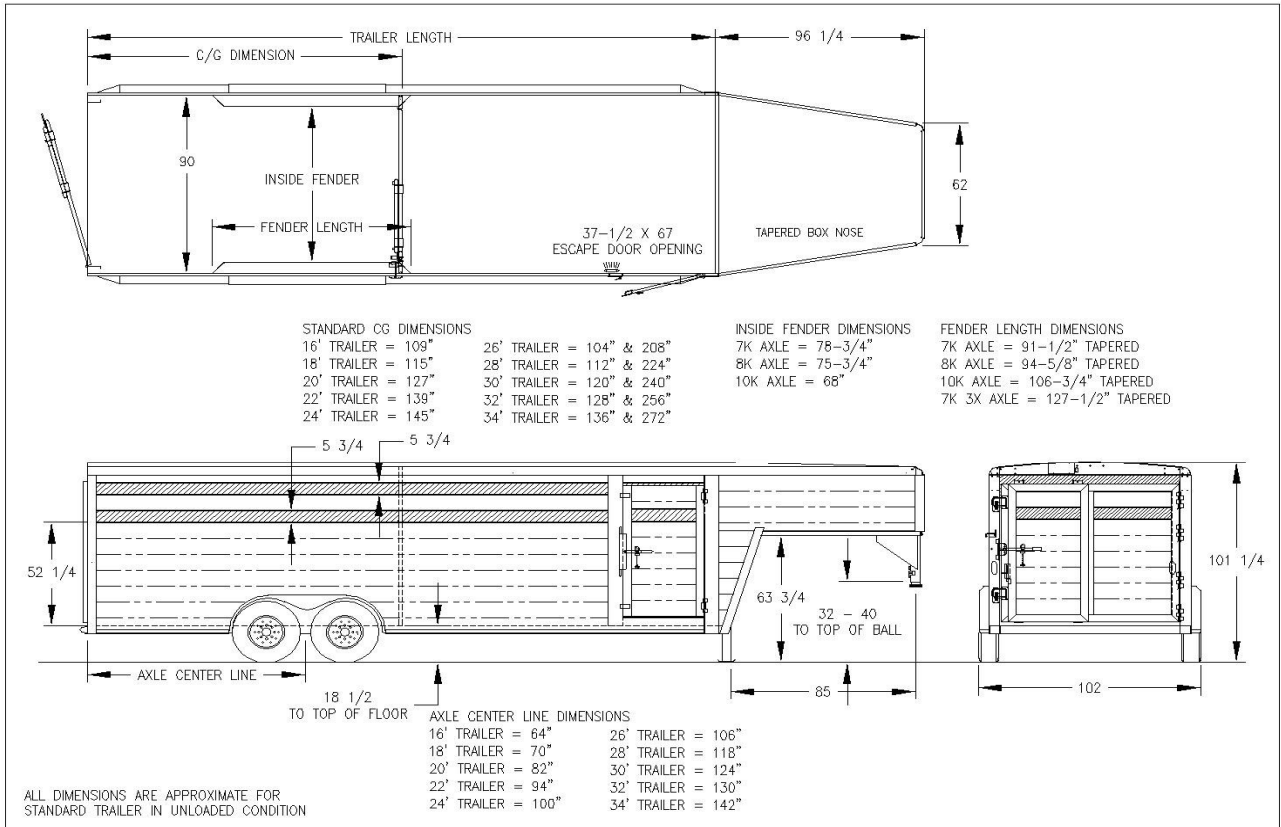

TITLE **7.5' WIDE X 6'8" TALL ENDURA LIVESTOCK TRAILER**

Hillsboro Industries  
220 Industrial Road  
Hillsboro, KS 67063

1-800-835-0209  
hi@hillsboroindustries.com  
www.hillsboroindustries.com

DWG NO. ??????	REV A	DATE 9-15	DRAWN BY APD	SCALE 1/60	PAGE
----------------	-------	-----------	--------------	------------	------

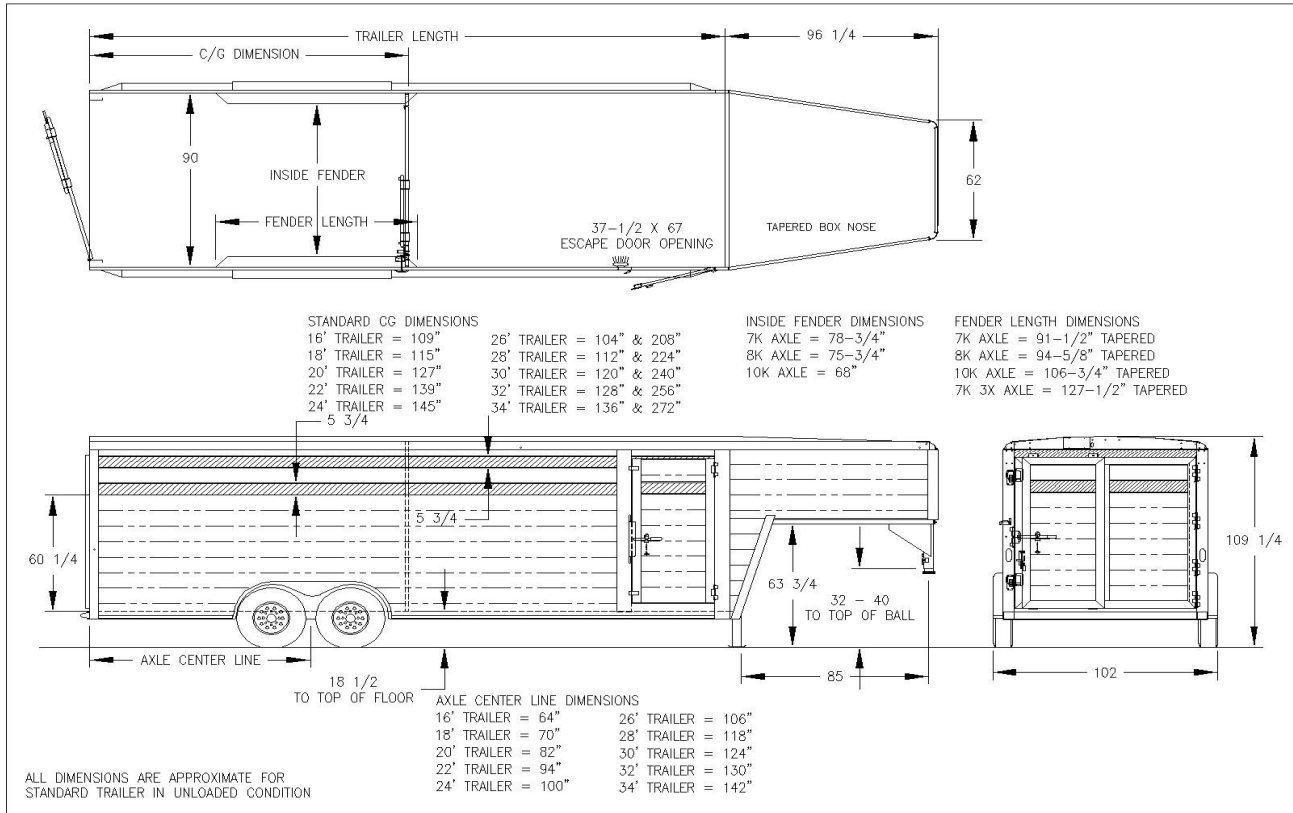

TITLE **7.5' WIDE X 7'4" TALL ENDURA LIVESTOCK TRAILER**

Hillsboro Industries  
220 Industrial Road  
Hillsboro, KS 67063

1-800-835-0209  
hi@hillsboroindustries.com  
www.hillsboroindustries.com

DWG NO. ??????	REV A	DATE 9-15	DRAWN BY APD	SCALE 1/60	PAGE
----------------	-------	-----------	--------------	------------	------

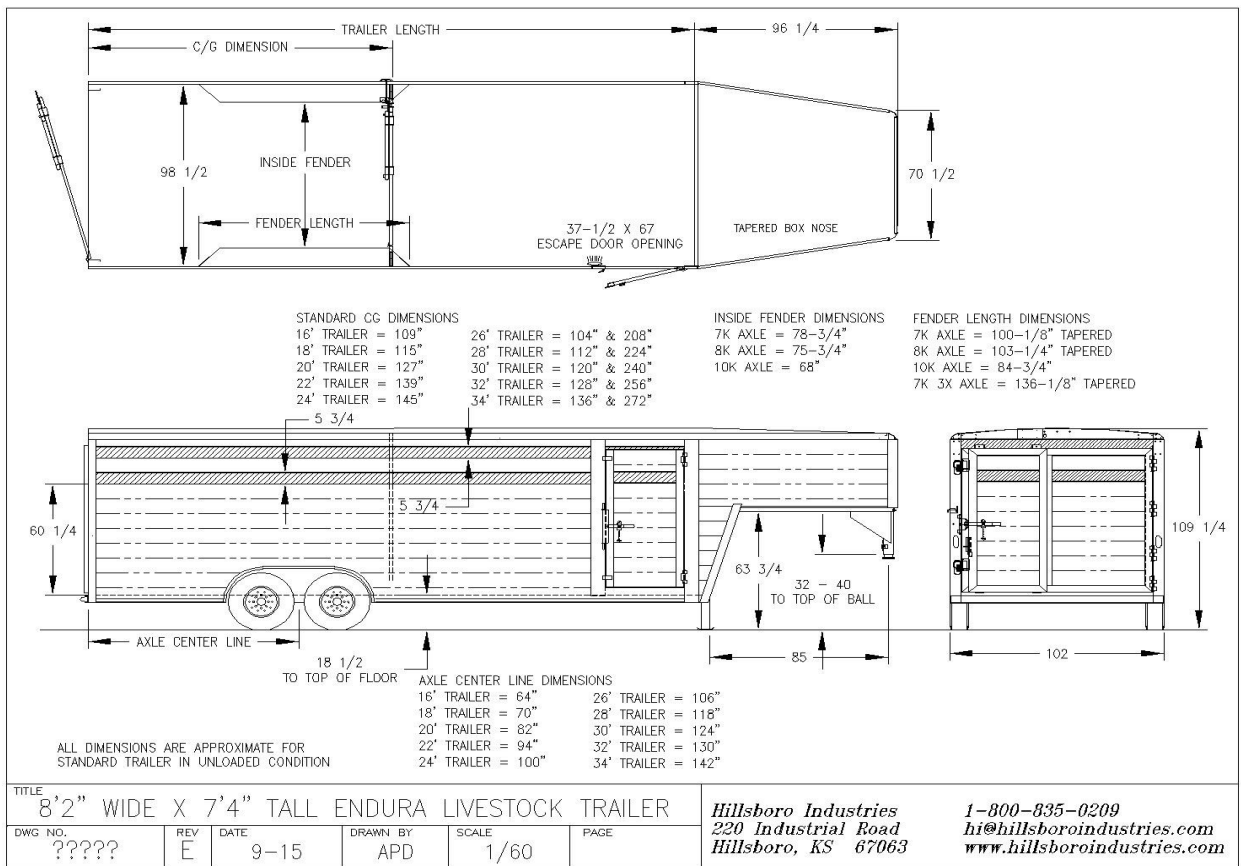
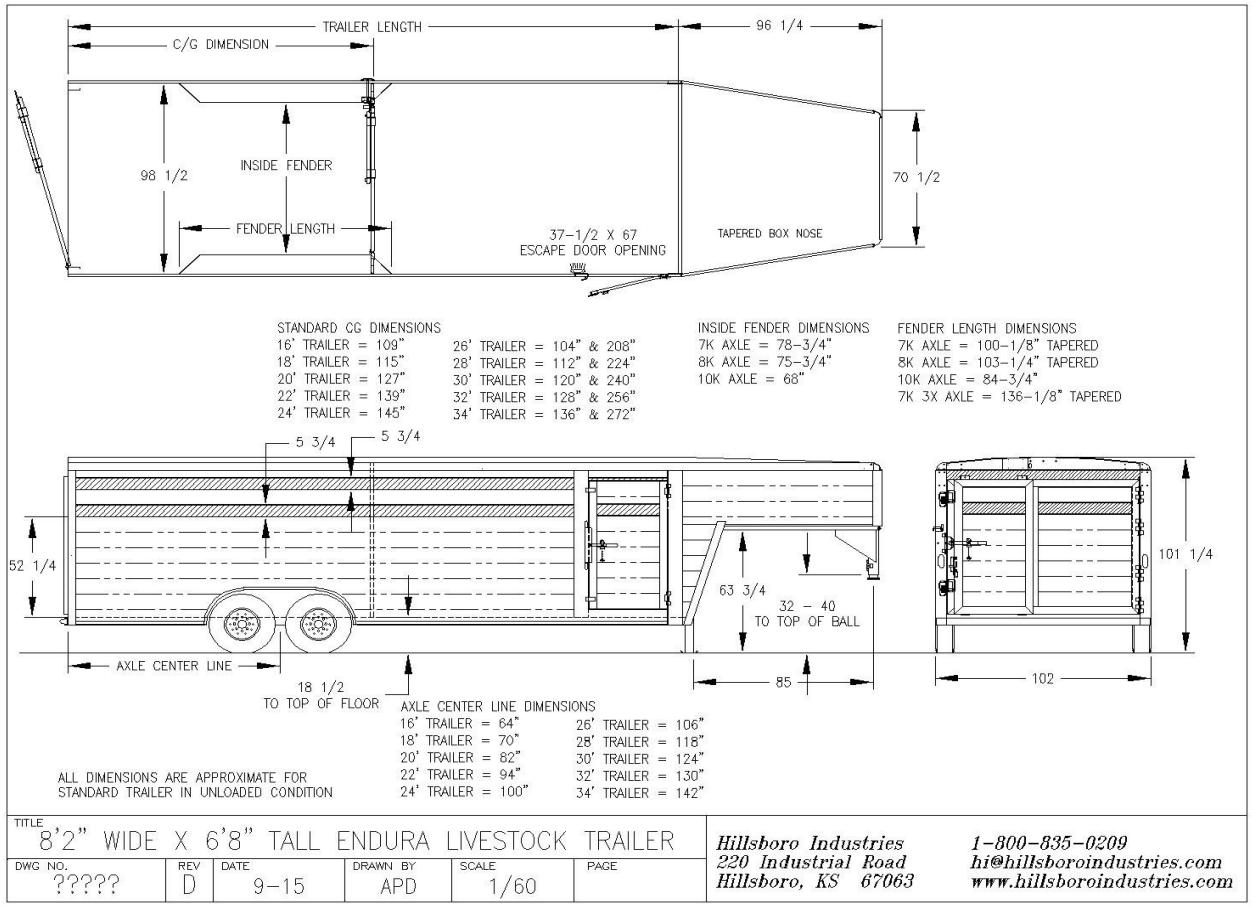

\*\*ALL PRICES SUBJECT TO CHANGE, FINAL PRICING WILL BE CONFIRMED THROUGH ORDER VERIFICATION\*\*  
 \*\*PRICE EFFECTIVITY IS BASED ON ECD OF ORDER\*\*

# ENDURA STOCK TRAILERS 7W CENTER GATE PASS-THROUGH WIDTH

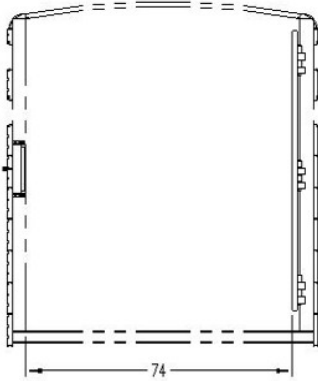

PASS-THROUGH WIDTH  
W/ 6K, 7K OR 7.2K AXLES  
SHOWN WITH CENTER GATE OPEN

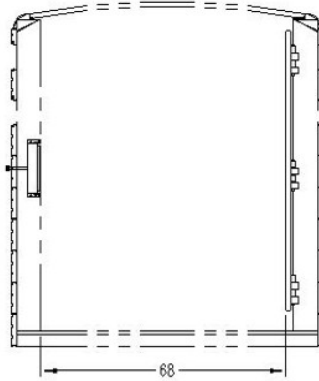

PASS-THROUGH WIDTH  
W/ 8K AXLES  
SHOWN WITH CENTER GATE OPEN

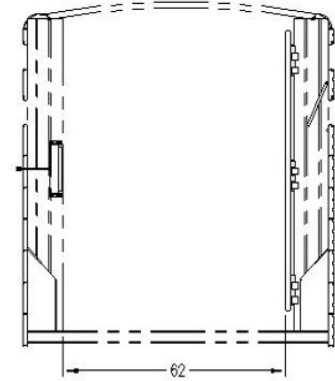

PASS-THROUGH WIDTH  
W/ 10K AXLES  
SHOWN WITH CENTER GATE OPEN

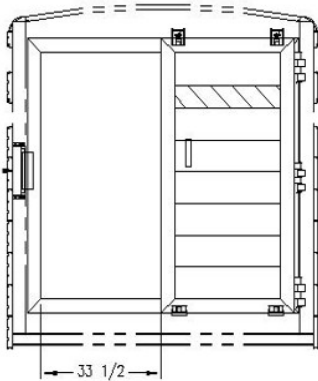

PASS-THROUGH WIDTH  
W/ 6K, 7K OR 7.2K AXLES  
SHOWN WITH ROLLER DOOR OPEN

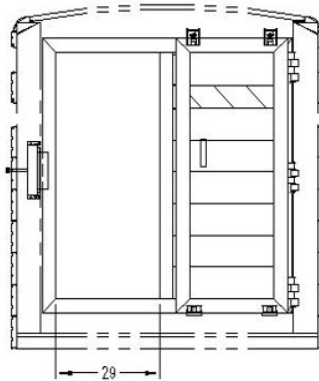

PASS-THROUGH WIDTH  
W/ 8K AXLES  
SHOWN WITH ROLLER DOOR OPEN

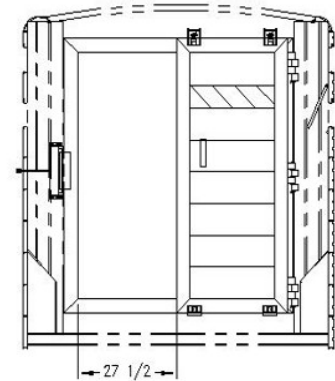

PASS-THROUGH WIDTH  
W/ 10K AXLES  
SHOWN WITH ROLLER DOOR OPEN

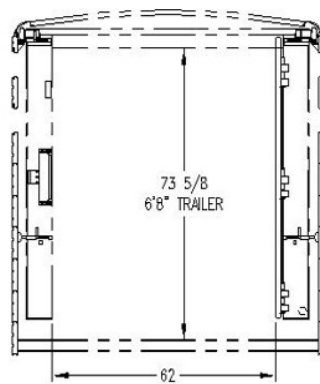

PASS-THROUGH DIMENSIONS  
ADJUSTABLE POSITION CENTER GATE

# ENDURA STOCK TRAILERS 7'6"W CENTER GATE PASS-THROUGH WIDTH

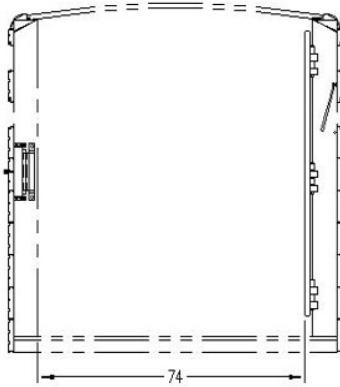

PASS-THROUGH WIDTH  
W/ 6K, 7K OR 7.2K AXLES  
SHOWN WITH CENTER GATE OPEN

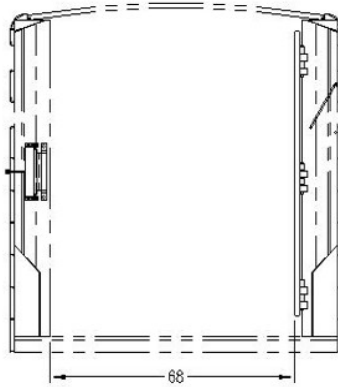

PASS-THROUGH WIDTH  
W/ 8K AXLES  
SHOWN WITH CENTER GATE OPEN

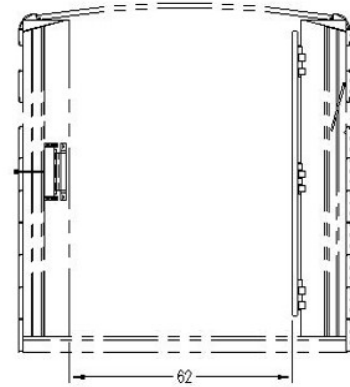

PASS-THROUGH WIDTH  
W/ 10K AXLES  
SHOWN WITH CENTER GATE OPEN

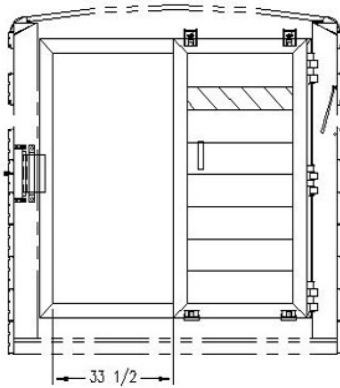

PASS-THROUGH WIDTH  
W/ 6K, 7K OR 7.2K AXLES  
SHOWN WITH ROLLER DOOR OPEN

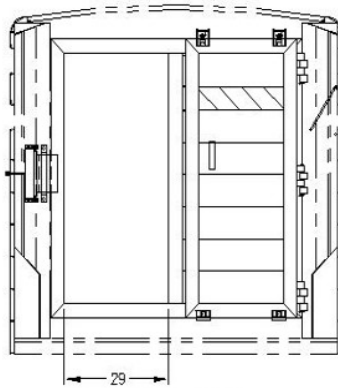

PASS-THROUGH WIDTH  
W/ 8K AXLES  
SHOWN WITH ROLLER DOOR OPEN

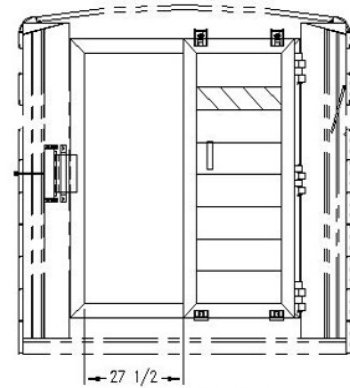

PASS-THROUGH WIDTH  
W/ 10K AXLES  
SHOWN WITH ROLLER DOOR OPEN

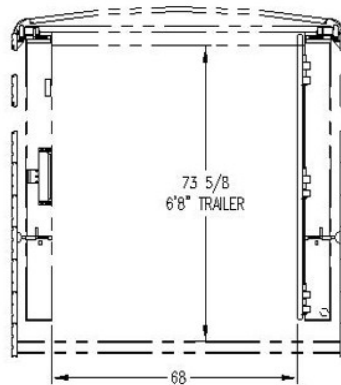

PASS-THROUGH DIMENSIONS  
ADJUSTABLE POSITION CENTER GATE

# ENDURA STOCK TRAILERS 8'2"W CENTER GATE PASS-THROUGH WIDTH

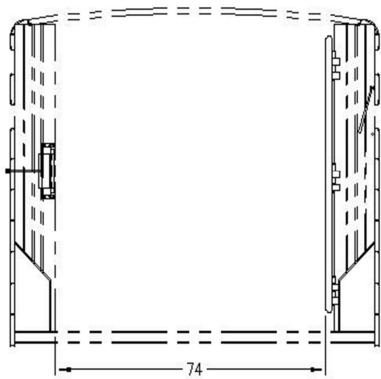

PASS-THROUGH WIDTH  
W/ 6K, 7K OR 7.2K AXLES  
SHOWN WITH CENTER GATE OPEN

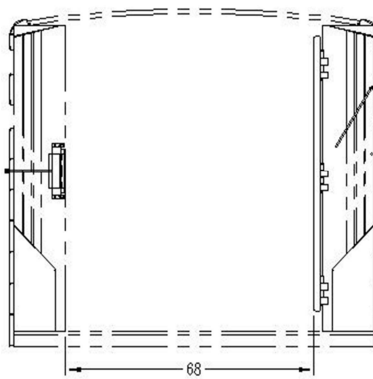

PASS-THROUGH WIDTH  
W/ 8K AXLES  
SHOWN WITH CENTER GATE OPEN

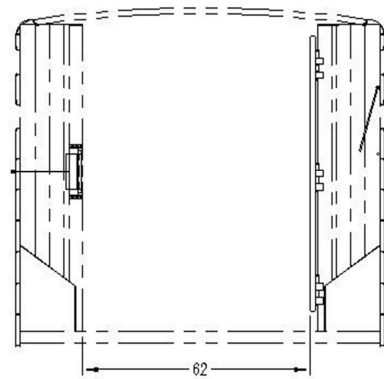

PASS-THROUGH WIDTH  
W/ 10K AXLES  
SHOWN WITH CENTER GATE OPEN

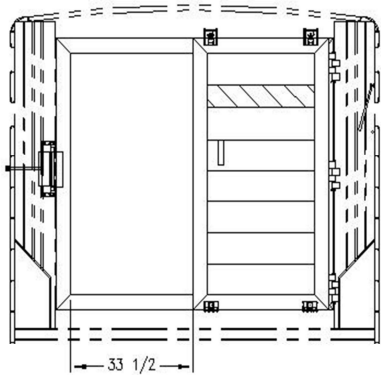

PASS-THROUGH WIDTH  
W/ 6K, 7K OR 7.2K AXLES  
SHOWN WITH CENTER GATE OPEN

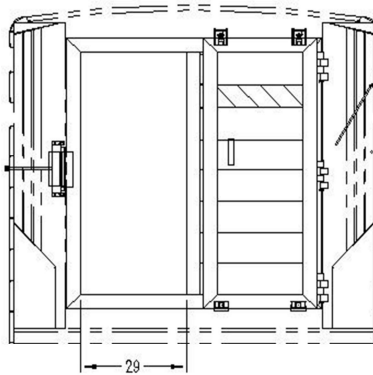

PASS-THROUGH WIDTH  
W/ 8K AXLES  
SHOWN WITH CENTER GATE OPEN

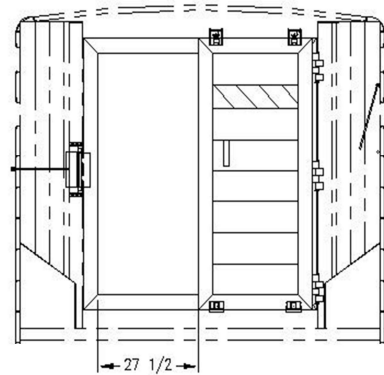

PASS-THROUGH WIDTH  
W/ 10K AXLES  
SHOWN WITH CENTER GATE OPEN

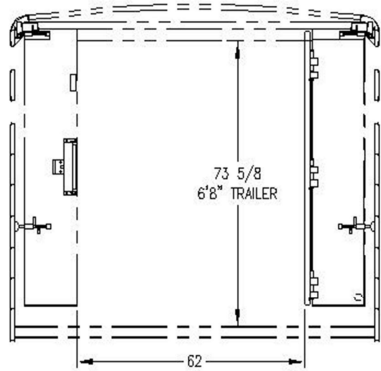

PASS-THROUGH DIMENSIONS  
ADJUSTABLE POSITION CENTER GATE

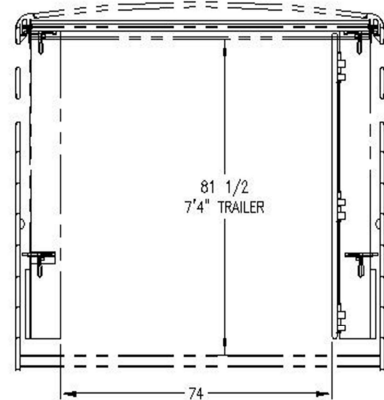

# REAR GATE CONFIGURATIONS, ENDURA STOCK TRAILERS 7W 6'8" T

## STANDARD CONFIGURATION

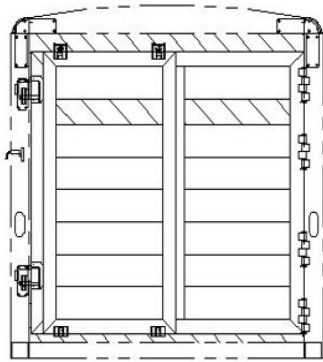

6'8" TALL, STANDARD LIVESTOCK SLIDER  
REAR OPENING - 76W X 76T

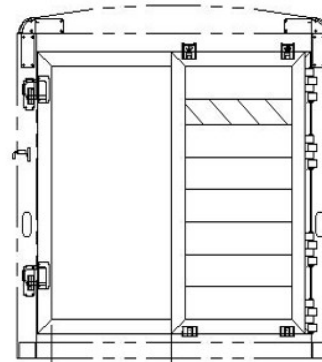

33 1/2  
PASS-THROUGH WIDTH  
STANDARD SLIDING REAR GATE  
SHOWN WITH ROLLER GATE OPEN

## OPTIONAL CONFIGURATIONS

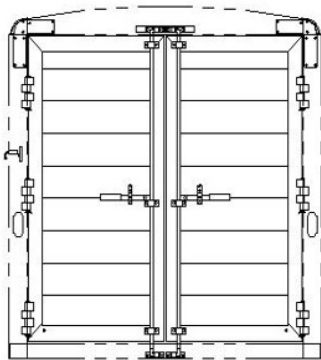

6'8" TALL, DOUBLE DOORS  
REAR OPENING - 74 3/8W X 75T  
CAM LATCH WITH STANDARD HINGES

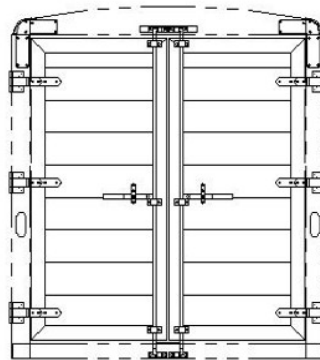

6'8" TALL, DOUBLE DOOR  
REAR OPENING - 74 3/8W X 75T  
CAM LATCH WITH LAY-FLAT HINGES

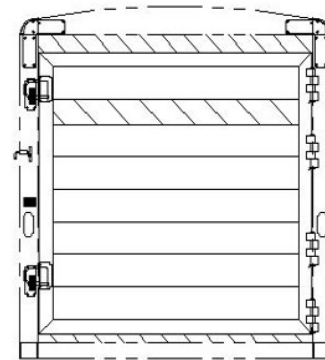

6'8" TALL, SOLID GATE  
REAR OPENING - 76W X 76T

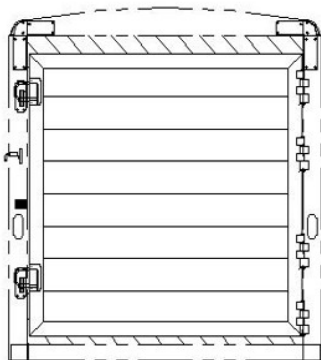

6'8" TALL, ENCLOSED SOLID GATE  
REAR OPENING - 76W X 76T

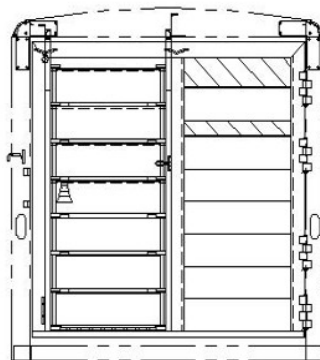

6'8" TALL, HALF ROLL-UP, 32 1/4" OPENING WIDTH  
REAR OPENING - 76W X 76T

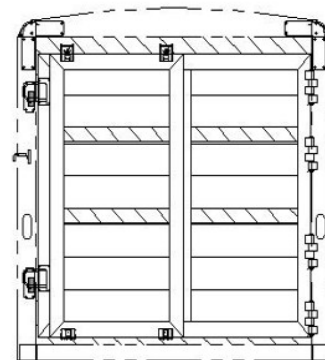

6'8" TALL, SLOTTED ROLLER GATE  
REAR OPENING - 76W X 76T

# REAR GATE CONFIGURATIONS, ENDURA STOCK TRAILERS 7W 7'4" T

## STANDARD CONFIGURATION

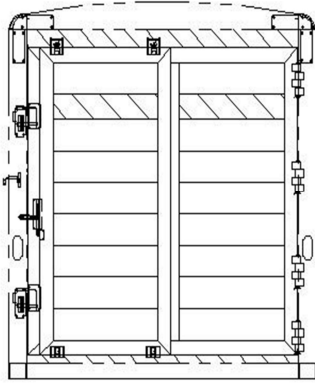

7'4" TALL, STANDARD LIVESTOCK SLIDER  
REAR OPENING - 76W X 84T

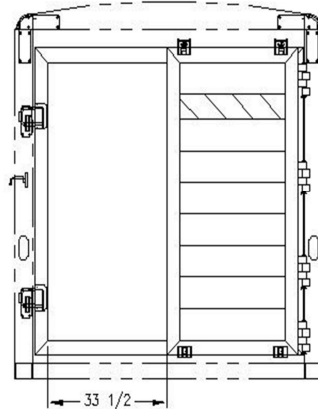

33 1/2  
PASS-THROUGH WIDTH  
STANDARD SLIDING REAR GATE  
SHOWN WITH ROLLER GATE OPEN

## OPTIONAL CONFIGURATIONS

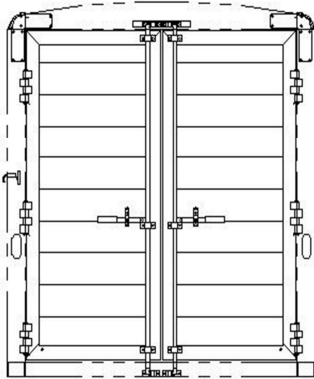

7'4" TALL, DOUBLE DOOR  
REAR OPENING - 74 3/8W X 83T  
CAM LATCH WITH STANDARD HINGES

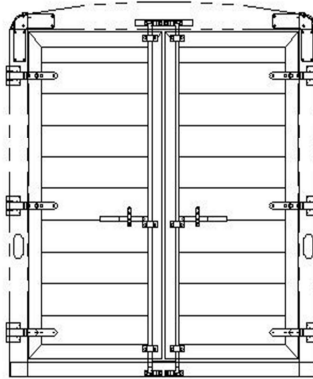

7'4" TALL, 7W, DOUBLE DOOR  
REAR OPENING - 74 3/8W X 83T  
CAM LATCH WITH LAY-FLAT HINGES

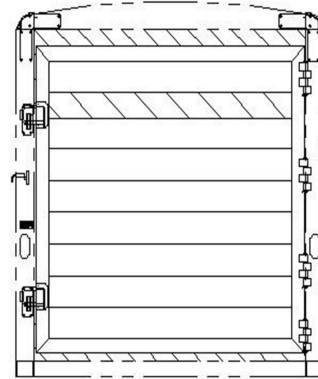

7'4" TALL, SOLID GATE  
REAR OPENING - 76W X 84T

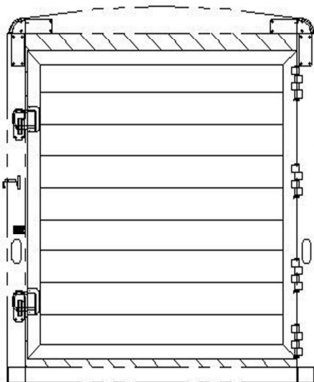

7'4" TALL, ENCLOSED SOLID GATE  
REAR OPENING - 76W X 84T

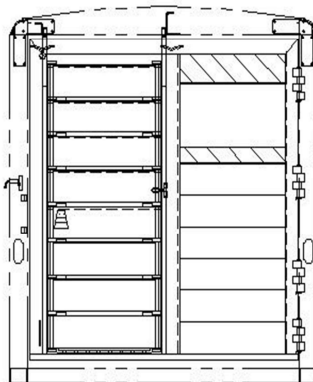

7'4" TALL, HALF ROLL-UP, 32 1/4" OPENING WIDTH  
REAR OPENING - 76W X 84T

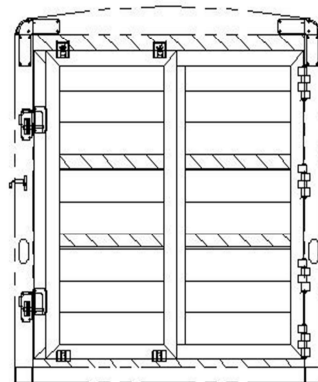

7'4" TALL, SLOTTED ROLLER GATE  
REAR OPENING - 76W X 84T

# REAR GATE CONFIGURATIONS, ENDURA STOCK TRAILERS 7'6"W 6'8"T

## STANDARD CONFIGURATION

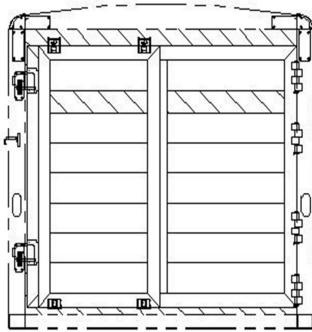

6'8" TALL, STANDARD LIVESTOCK SLIDER  
REAR OPENING - 82W X 76T

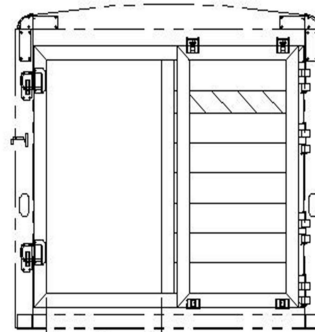

35  
PASS-THROUGH WIDTH  
STANDARD SLIDING REAR GATE  
SHOWN WITH ROLLER GATE OPEN

## OPTIONAL CONFIGURATIONS

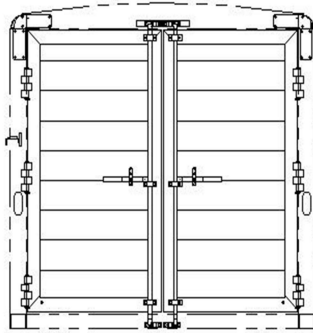

6'8" TALL, DOUBLE DOORS  
REAR OPENING - 88 7/8W X 75T  
CAM LATCH WITH STANDARD HINGES

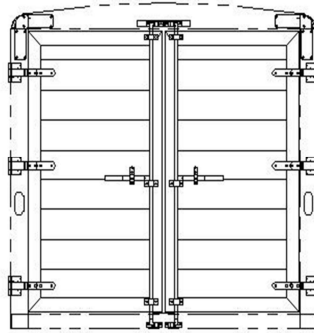

6'8" TALL, DOUBLE DOOR  
REAR OPENING - 88 7/8W X 75T  
CAM LATCH WITH LAY-FLAT HINGES

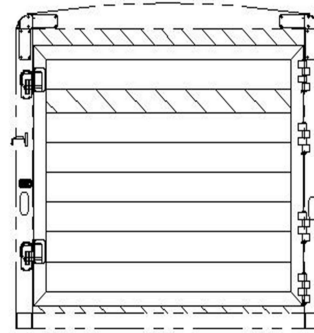

6'8" TALL, SOLID GATE  
REAR OPENING - 82W X 76T

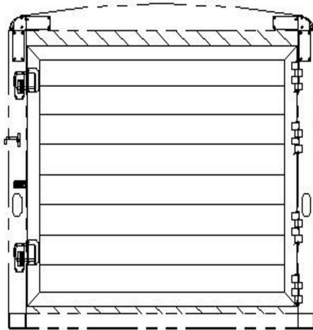

6'8" TALL, ENCLOSED SOLID GATE  
REAR OPENING - 82W X 76T

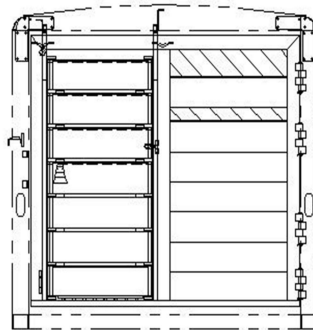

6'8" TALL, HALF ROLL-UP, 32 1/4" OPENING WIDTH  
REAR OPENING - 82W X 76T

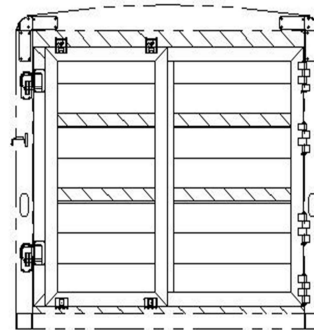

6'8" TALL, SLOTTED ROLLER GATE  
REAR OPENING - 82W X 76T

# REAR GATE CONFIGURATIONS, ENDURA STOCK TRAILERS 7'6"W 7'4"

## STANDARD CONFIGURATION

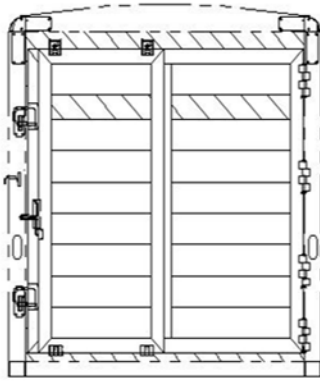

7'4" TALL, STANDARD LIVESTOCK SLIDER  
REAR OPENING - 82W X 84T

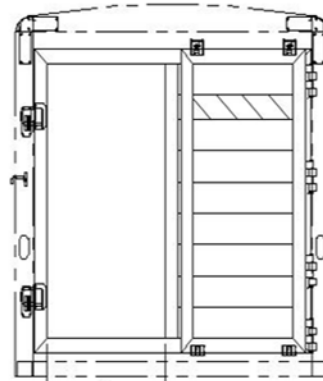

35  
PASS-THROUGH WIDTH  
STANDARD SLIDING REAR GATE  
SHOWN WITH ROLLER GATE OPEN

## OPTIONAL CONFIGURATIONS

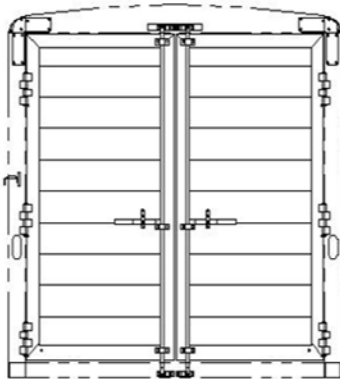

7'4" TALL, DOUBLE DOOR  
REAR OPENING - 88 7/8W X 83T  
CAM LATCH WITH STANDARD HINGES

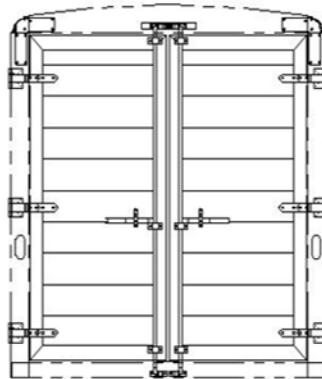

7'4" TALL, DOUBLE DOOR  
REAR OPENING - 88 7/8W X 83T  
CAM LATCH WITH LAY-FLAT HINGES

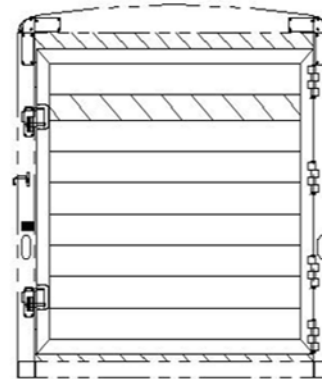

7'4" TALL, SOLID GATE  
REAR OPENING - 82W X 84T

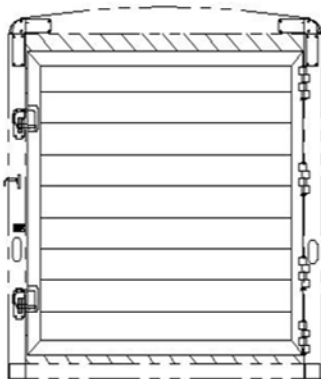

7'4" TALL, ENCLOSED SOLID GATE  
REAR OPENING - 82W X 84T

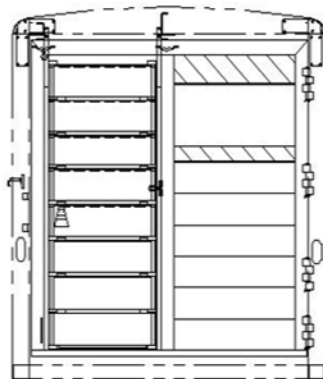

7'4" TALL, HALF ROLL-UP, 32 1/4" OPENING WIDTH  
REAR OPENING - 82W X 84T

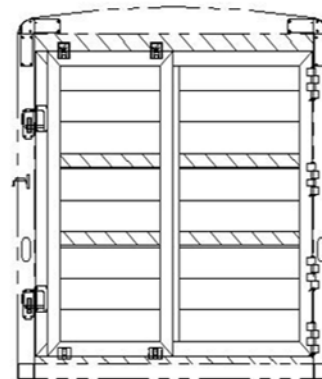

7'4" TALL, SLOTTED ROLLER GATE  
REAR OPENING - 82W X 84T

# REAR GATE CONFIGURATIONS, ENDURA STOCK TRAILERS 8'2"W 6'8"T

## STANDARD CONFIGURATION

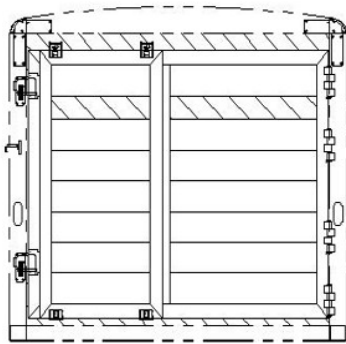

6'8" TALL, STANDARD LIVESTOCK SLIDER  
REAR OPENING - 90 1/2" W X 76" T

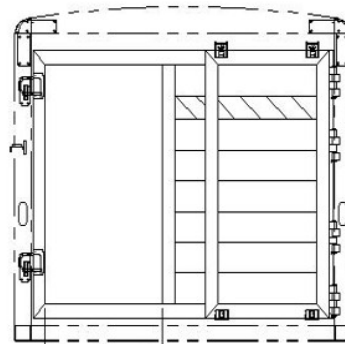

35"  
PASS-THROUGH WIDTH  
STANDARD SLIDING REAR GATE  
SHOWN WITH ROLLER GATE OPEN

## OPTIONAL CONFIGURATIONS

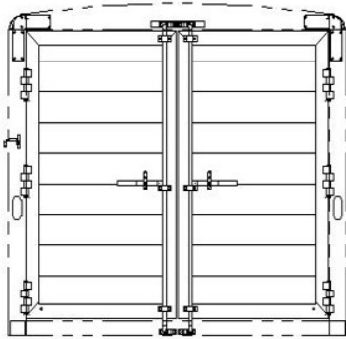

6'8" TALL, DOUBLE DOORS  
REAR OPENING - 88 7/8" W X 75" T  
CAM LATCH WITH STANDARD HINGES

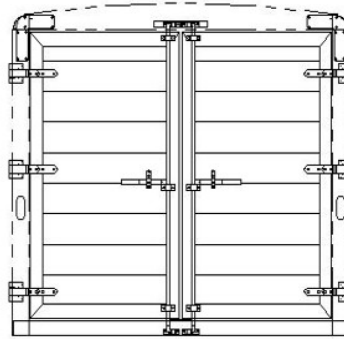

6'8" TALL, DOUBLE DOOR  
REAR OPENING - 88 7/8" W X 75" T  
CAM LATCH WITH LAY-FLAT HINGES

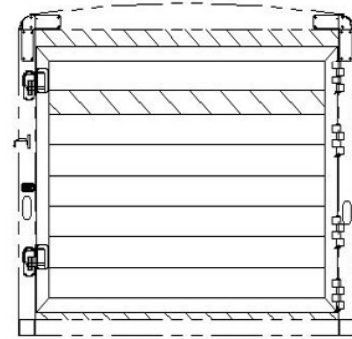

6'8" TALL, SOLID GATE  
REAR OPENING - 90 1/2" W X 76" T

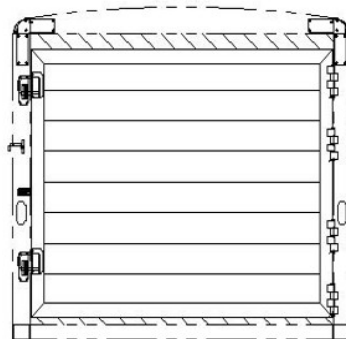

6'8" TALL, ENCLOSED SOLID GATE  
REAR OPENING - 90 1/2" W X 76" T

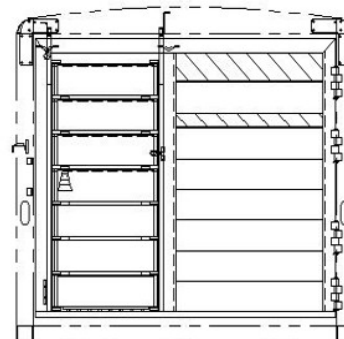

6'8" TALL, HALF ROLL-UP, 32 1/4" OPENING WIDTH  
REAR OPENING - 90 1/2" W X 76" T

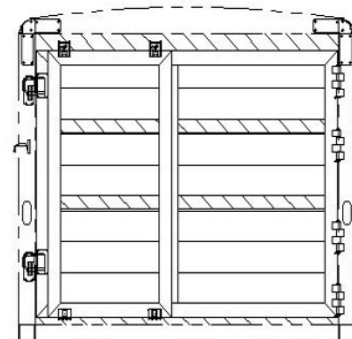

6'8" TALL, SLOTTED ROLLER GATE  
REAR OPENING - 90 1/2" W X 76" T

# REAR GATE CONFIGURATIONS, ENDURA STOCK TRAILERS 8'2"W 7'4"T

## STANDARD CONFIGURATION

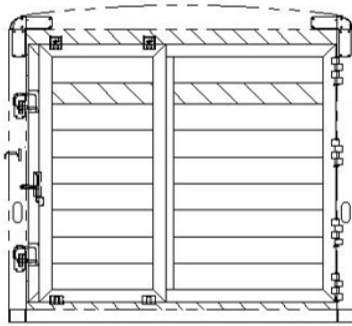

7'4" TALL, STANDARD LIVESTOCK SLIDER  
REAR OPENING - 90 1/2W X 84T

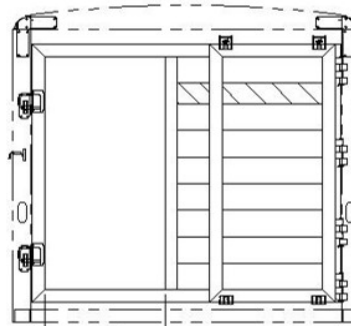

35  
PASS-THROUGH WIDTH  
STANDARD SLIDING REAR GATE  
SHOWN WITH ROLLER GATE OPEN

## OPTIONAL CONFIGURATIONS

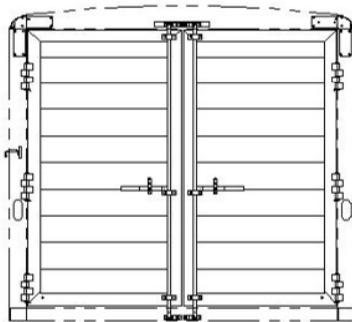

7'4" TALL, DOUBLE DOOR  
REAR OPENING - 88 7/8W X 83T  
CAM LATCH WITH STANDARD HINGES

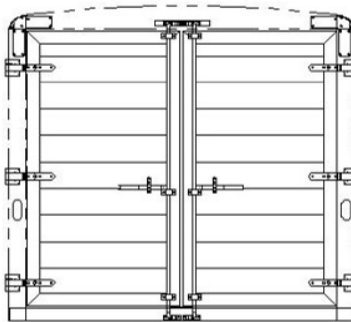

7'4" TALL, DOUBLE DOOR  
REAR OPENING - 88 7/8W X 83T  
CAM LATCH WITH LAY-FLAT HINGES

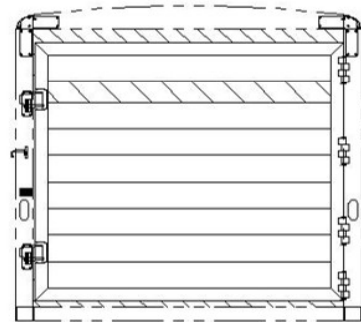

7'4" TALL, SOLID GATE  
REAR OPENING - 90 1/2W X 84T

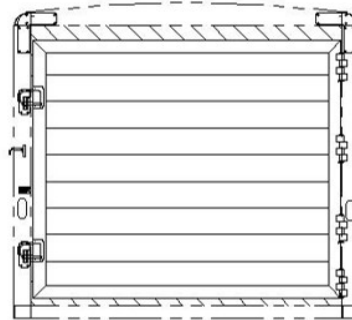

7'4" TALL, ENCLOSED SOLID GATE  
REAR OPENING - 90 1/2W X 84T

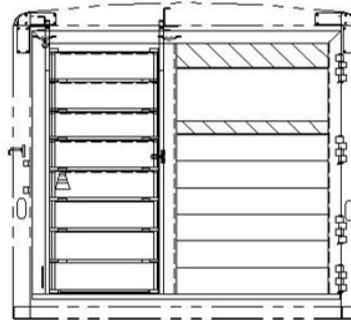

7'4" TALL, HALF ROLL-UP, 32 1/4" OPENING WIDTH  
REAR OPENING - 90 1/2W X 84T

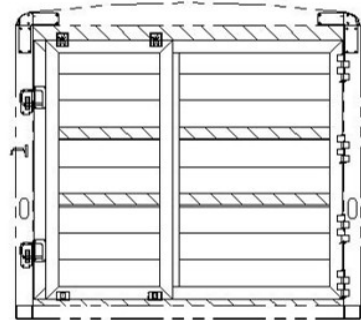

7'4" TALL, SLOTTED ROLLER GATE  
REAR OPENING - 90 1/2W X 84T

ENDURA ALUMINUM TRAILER  
 7' X 16' (3) HORSE COMBO  
 6'8"/7'4" TALL

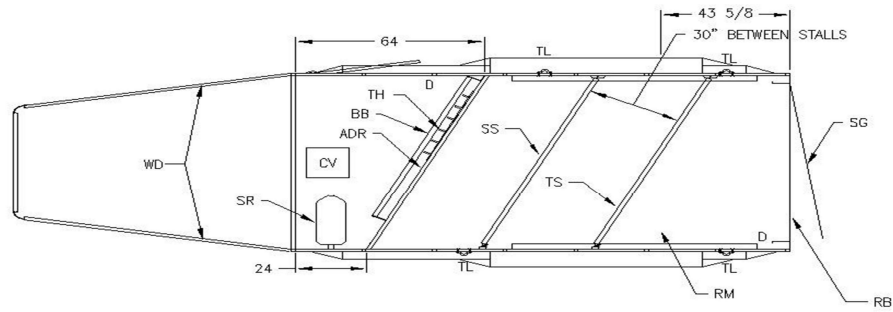

- |                                      |   |
|--------------------------------------|---|
| WD = 15 X 34 WINDOWS                 | TH = TACK HOOKS                         |
| D = DOME LIGHTS (2)                  | SR = 3 PEDESTAL SADDLE RACK FOR 3 HORSE |
| TL = TIE LOOPS (4) BOLT-ON           | SR = 4 PEDESTAL SADDLE RACK FOR 4 HORSE |
| BB = BLANKET BAR                     | CV = CRANK-UP ROOF VENT                 |
| SG = SLIDING REAR GATE               | ADR = ANGLED DRESSING ROOM              |
| SS = SLANT STALL DIVIDER             | RB = RUBBER BUMPER                      |
| TS = TELESCOPING SLANT STALL DIVIDER | RM = RUBBER MAT ON FLOOR                |

ENDURA ALUMINUM TRAILER  
 7' X 20' (4) HORSE COMBO  
 6'8"/7'4" TALL

